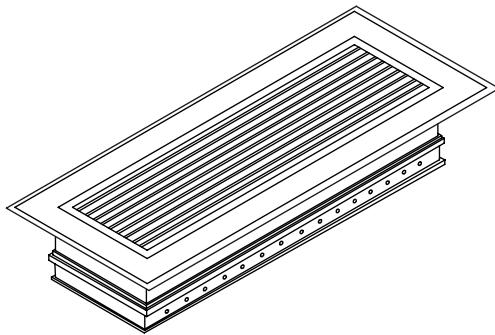

AFP Series
Aluminum Floor Perimeter Diffuser

Standard:

- All .06 extruded aluminum construction
- Reinforced with pressure locks and honeycomb construction to withstand heavy foot traffic
- 1/8" bars spaced on 1/2" centers, 0° deflection
- Recessed screwdriver operated opposed blade damper to control air volume for positive balance of system
- Positive volume set screw
- Satin Anodized finish

Optional:

- 20° deflection

Finishes:

- Soft White
- Driftwood Tan

Designer Colors:

- | | |
|--|---------------------------------------|
| <input type="checkbox"/> Navajo White | <input type="checkbox"/> Royal Blue |
| <input type="checkbox"/> Forest Green | <input type="checkbox"/> Coffee Tan |
| <input type="checkbox"/> Burgundy | <input type="checkbox"/> Almond |
| <input type="checkbox"/> Camaro Silver | <input type="checkbox"/> Black Velvet |
| <input type="checkbox"/> Bronze | <input type="checkbox"/> Vanilla |

- Bronze Finish
- Gym Grade (AFP GG)
- Blades parallel to shortest dimension
- Grille only (AFG)

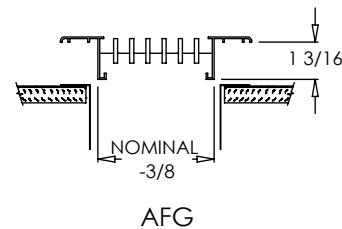
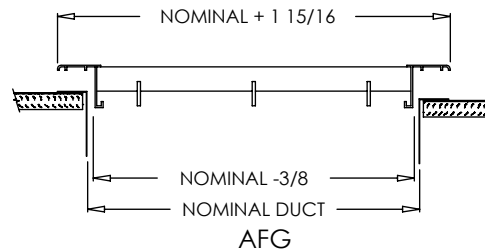
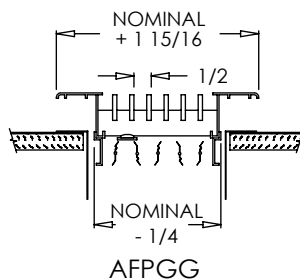
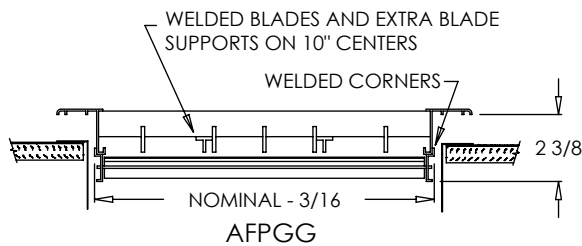
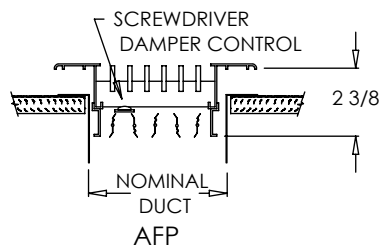
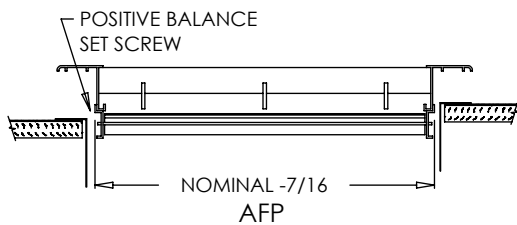

PROJECT	SUBMITTAL REVIEW
LOCATION	
ENGINEER	
ARCHITECT	
CONTRACTOR	