

### MA Series Modular Core Diffuser

#### Standard:

- Modular core ceiling diffuser
- Modular core has galvanneal steel blades in .055 T6 extruded aluminum frame
- Movable cores provide multiple fixed air patterns
- Square collar
- Countersunk mounting holes for flush appearance with color matching Phillips posi-drive screws
- Soft White

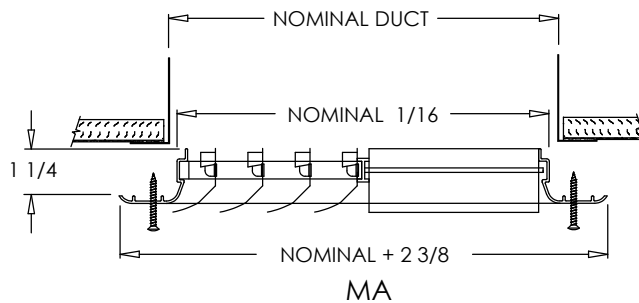

#### Optional:

- Recessed screwdriver operated Opposed Blade Damper (MA O)
- Square to round No Labor Collar
- Driftwood Tan

#### Designer Colors:

- |  |                                       |
|--|---------------------------------------|
| <input type="checkbox"/> Navajo White  | <input type="checkbox"/> Royal Blue   |
| <input type="checkbox"/> Forest Green  | <input type="checkbox"/> Coffee Tan   |
| <input type="checkbox"/> Burgundy      | <input type="checkbox"/> Almond       |
| <input type="checkbox"/> Camaro Silver | <input type="checkbox"/> Black Velvet |
| <input type="checkbox"/> Bronze        | <input type="checkbox"/> Vanilla      |

- Concealed mount (MA CM)

#### Tamper Proof Screws:

- "E" One Way
- "F" Torx Center Pin
- "G" Hex Center Pin

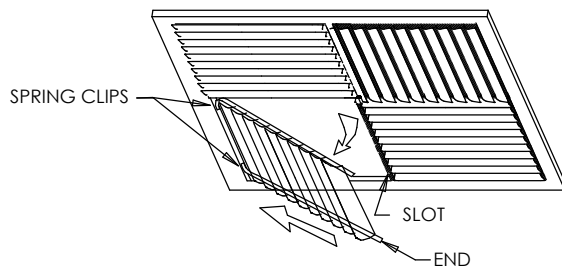
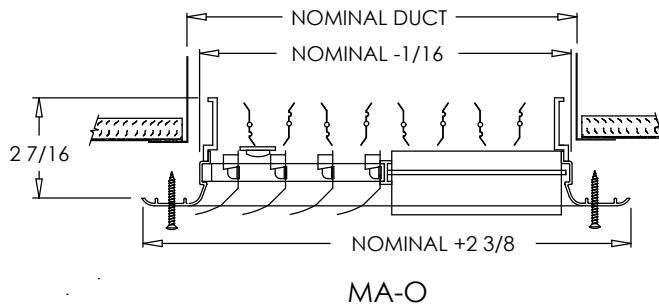

TO REMOVE - COMPRESS SPRING CLIPS & LIFT END FROM SLOT

PROJECT	SUBMITTAL REVIEW
LOCATION	
ENGINEER	
ARCHITECT	
CONTRACTOR	

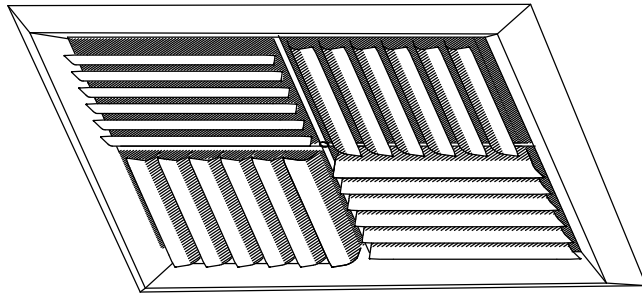

**MA DCF Series  
Deep Ceiling Frame  
Modular Core Diffuser**

**Standard:**

- Modular core ceiling diffuser
- Modular core has galvaneal steel blades
- Steel frame design prevents smudging of ceiling surface area surrounding diffuser
- Movable cores provide multiple fixed air patterns
- Square collar
- Countersunk mounting holes for flush appearance with color matching Phillips posi-drive screws
- Soft White

**Optional:**

- Recessed screwdriver operated Opposed Blade Damper (MA DCF-O)
- Square to round No Labor Collar

**Finishes:**

- Driftwood Tan
- Designer Colors
- Concealed mount (MA DCF-CM)

**Tamper Proof Screws:**

- "E" One Way
- "F" Torx Center Pin
- "G" Hex Center Pin

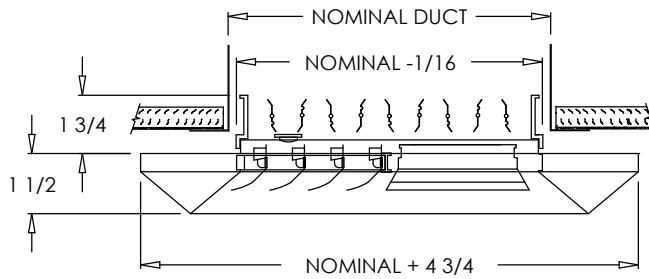

MA DCF-O

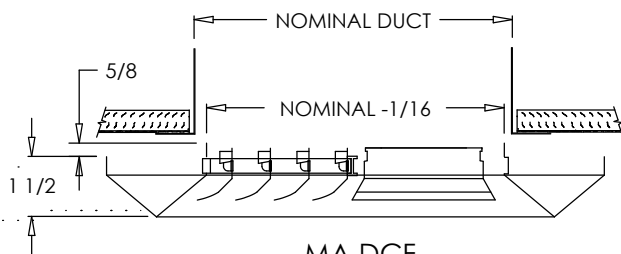

MA DCF

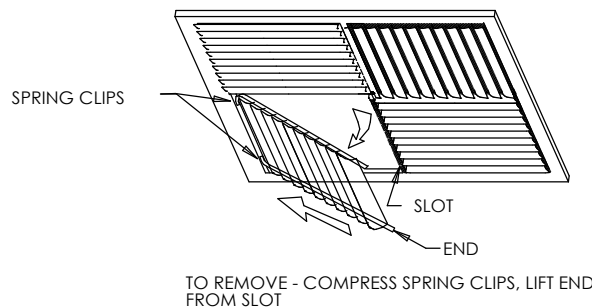
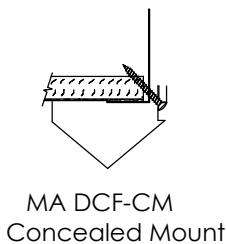

PROJECT	SUBMITTAL REVIEW
LOCATION	
ENGINEER	
ARCHITECT	
CONTRACTOR	