

# Pfister®

**Woodbury™**

BTB-WD1 • BTB-WD2

18 or 24" Towel Bar  
Toallero de Barra de 18 o 24"  
Porte-Serviette du 18 ou 24"

Installation Guide  
Guía de Instalación  
Guide d'Installation

## Installation Support • Soporte de Instalación • Support d'Installation

For Warranty & Care Information or Ordering  
Replacement Parts:

Para información sobre la garantía y el  
mantenimiento o para ordenar piezas de repuesto:

Pour renseignements sur la garantie et l'entretien  
ou pour commander des pièces de rechange:

**1-800-PFAUCET (732-8238)**  
**pfisterfaucets.com/support**



**WARNING / ADVERTENCIA / AVERTISSEMENT**

**To reduce the risk of injury or property damage, read all instructions before installing product. Wear safety goggles, and call a professional if you are uncertain about installing this product.**

Para disminuir el riesgo de lesiones o daños a la propiedad, lea todas las instrucciones antes de instalar el producto. Utilizar gafas de seguridad, y llame a un profesional si tiene dudas sobre la instalación de este producto.

Pour réduire le risque de blessures ou de dommages, lisez toutes les instructions avant d'installer ce produit. Portez des lunettes de sécurité, et appelez un professionnel si vous n'êtes pas sûr à propos de l'installation.

### Required Tools • Herramientas necesarias • Outils nécessaires



Level  
Burbuja de nivel  
Niveau à Bulle



Hammer  
Martillo  
Marteau



Pencil  
Lápiz  
Crayon



Phillips Screwdriver  
Destornillador de estrella  
Tournevis Phillips



Tape  
Cinta  
Ruban



Safety Goggles  
Gafas de seguridad  
Lunettes de sécurité



Power Drill  
Taladro Eléctrico  
Foreuse Électrique



1/4" or 1/8" Bits  
1/4" o 1/8" Brocas  
1/4" ou 1/8" Forets

### Parts in the Box • Piezas en la caja • Contenu de la boîte



**A**



**B**

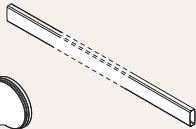

**C**



**D (x4)**



**E (x2)**



**F (x4)**



2mm Hex Wrench  
Llave hexagonal de 2mm  
Cle hexagonale du 2mm



**G**

# 1

## Preparation Preparación Préparation



Tape  
Cinta  
Ruban

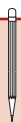

Pencil  
Lápiz  
Crayon



Level  
Burbuja de nivel  
Niveau à Bulle



G

### 1A

**Use the Template Screw Hole Markings (A&C) for 18" (457 mm) and (A&B) for 24" (610 mm).**

Utilice las marcas de agujeros para tornillos de la plantilla (A y C) para 18 pulg. (457 mm) y (A y B) para 24 pulg. (610 mm) para instalaren el lugar deseado.

Utilisez le modèle pour marquer les trous de vis, (A et C) pour les barres de 18 po. (457 mm) et (A et B) pour les barres de 24 po. (610 mm).

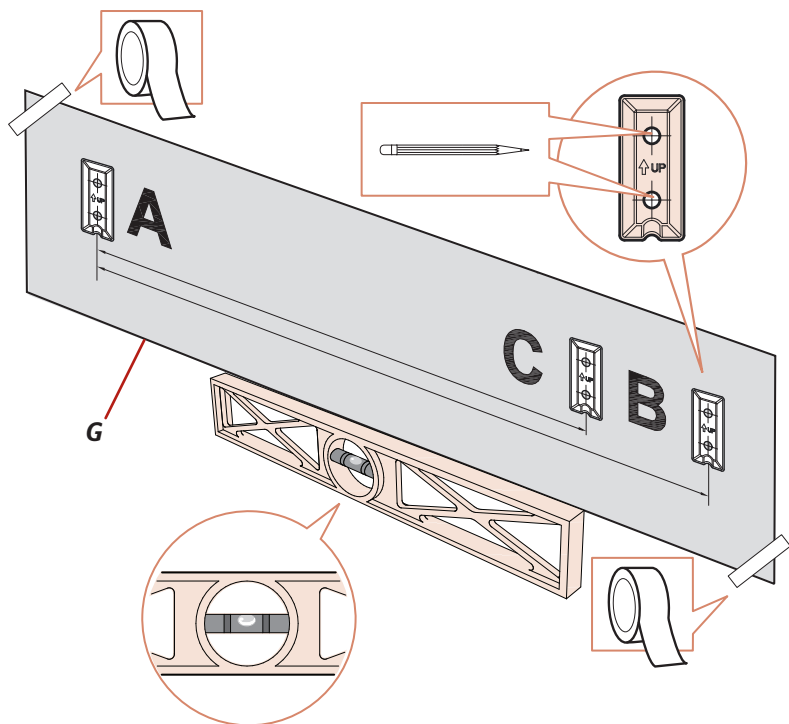

**Use the template as shown. Template must be horizontally leveled.**

Utilice la plantilla como se muestra. La plantilla debe estar nivelada horizontalmente.

Utilisez le gabarit comme indiqué. Le modèle doit être parfaitement horizontal.

## 2

### Bracket Installation: Studs Installation

### Intalación del soporte: Instalación del Montantes

### Installation des supports de fixation: Installation du Montant

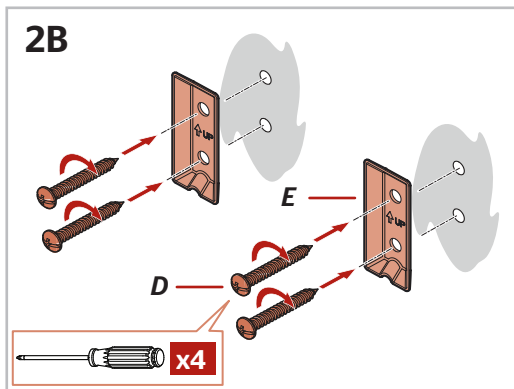
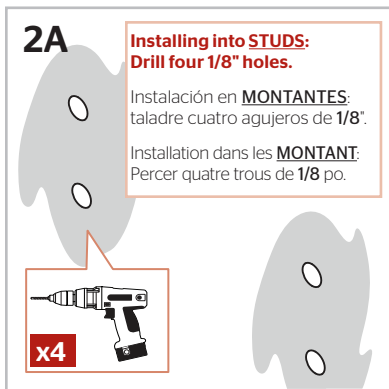
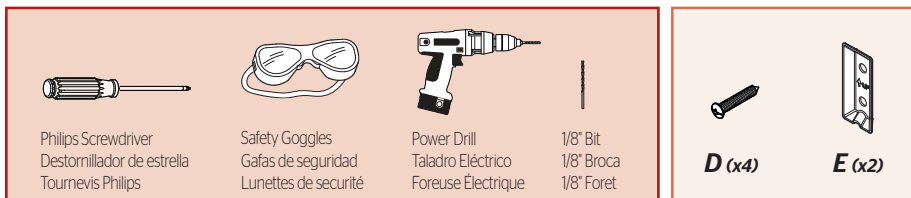

## 2

### Bracket Installation: Drywall Installation

### Intalación del soporte: Instalación de paneles de yeso

### Installation des supports de fixation: Installation de cloisons sèches

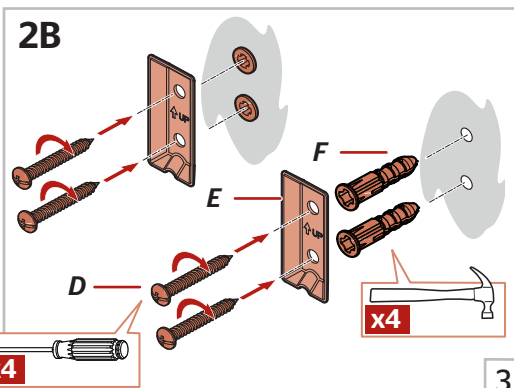
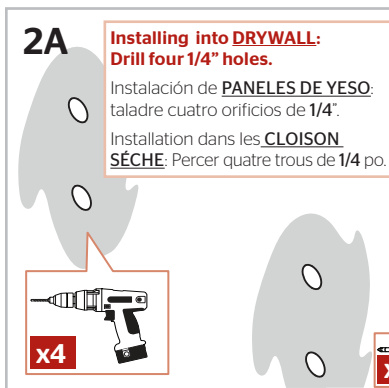
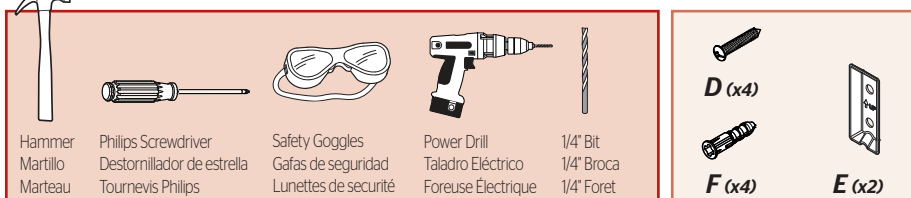

# 3

## Towel Bar Installation Instalación del toallero de barra Installation du porte-serviette

1

2mm Hex Wrench  
Llave hexagonal de 2mm  
Cle hexagonale du 2mm

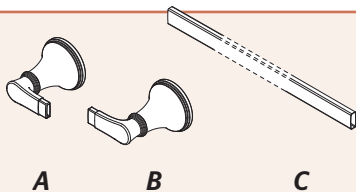

### 3A

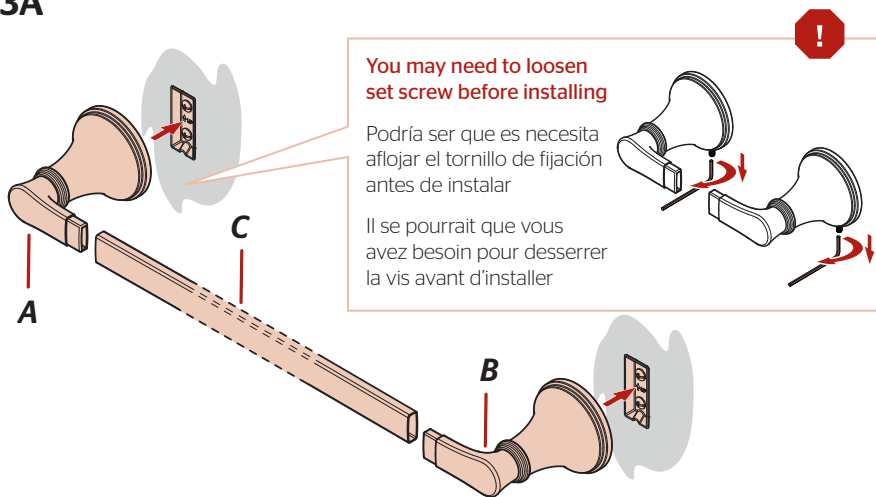

### 3B

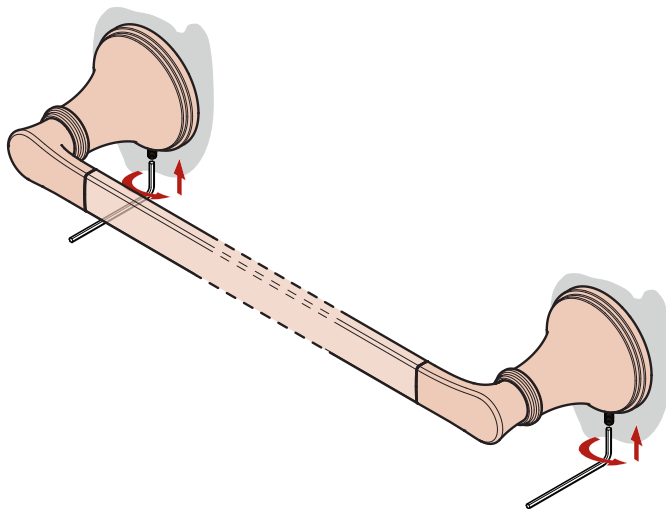

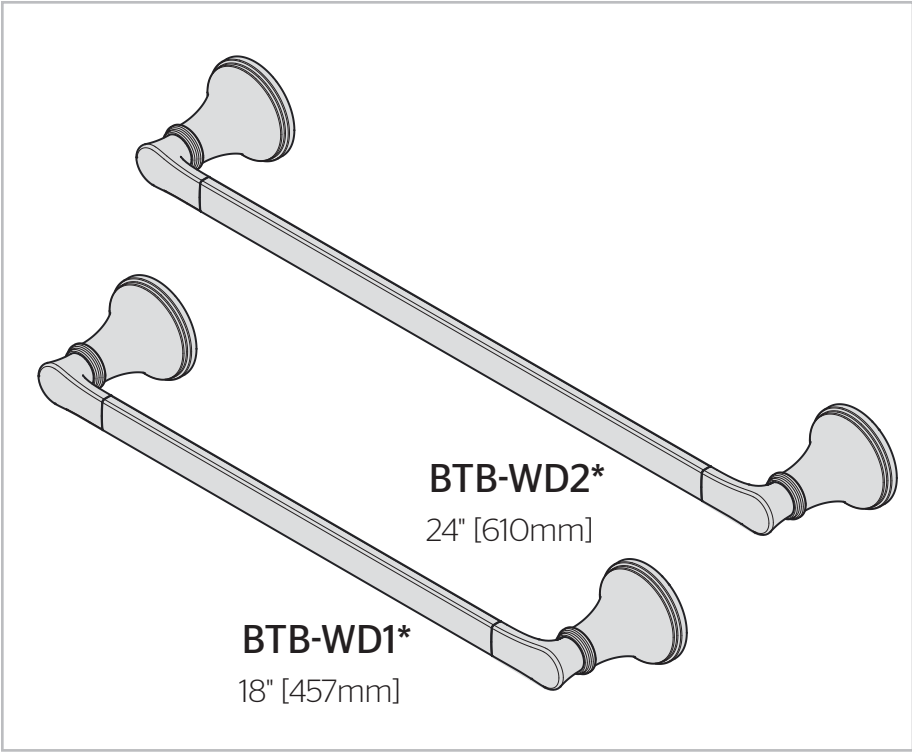

**Spare Parts**

Piezas de repuesto

Pièces de rechange

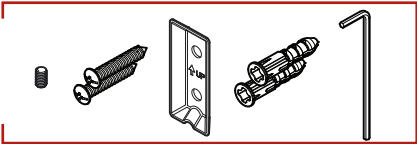

931-129-PF

| ✦  | English                          | Español                           | Français                        |
|----|----------------------------------|-----------------------------------|---------------------------------|
| C  | Polished Chrome                  | Cromo Pulido                      | Chrome Poli                     |
| GS | Brushed Nickel with Spot Defense | Niquel Cepillado con Spot Defense | Nickel Brossé avec Spot Defense |
| Y  | Tuscan Bronze                    | Bronce Toscano                    | Bronze Le Toscan                |

**CLEANING INSTRUCTIONS: Use only a soft damp cloth to clean and shine. Use of polish, detergents, abrasive cleaners, organic solvents, or acid may cause damage. Use of other than a soft damp cloth will nullify our warranty!**

INSTRUCCIONES PARA LIMPIEZA: Use solamente un paño suave y húmedo. El uso de pulidores, detergentes, limpiadores abrasivos, solventes orgánicos o ácidos puede provocar daños. ¡El uso de algo más que un paño suave y húmedo invalida nuestra garantía!

INSTRUCTION DE NETTOYAGE: Utilisez uniquement un chiffon doux et humide pour nettoyer et faire briller. L'utilisation de polir, de détergents, de nettoyeurs abrasifs, les solvants organiques, ou acide peuvent causer des dommages. L'utilisation d'autres d'un chiffon doux humide annulera la garantie!