

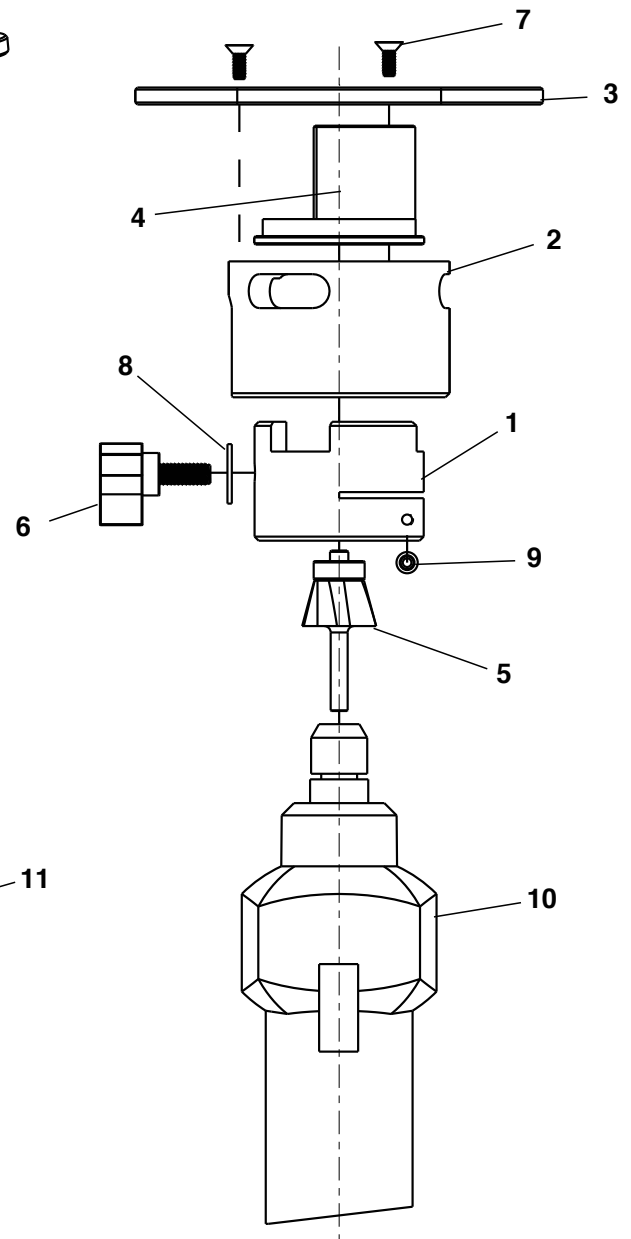

PIPE TOOLS & VISES
SINCE 1896

Cordless Power Pipe Beveler

Replacement Parts

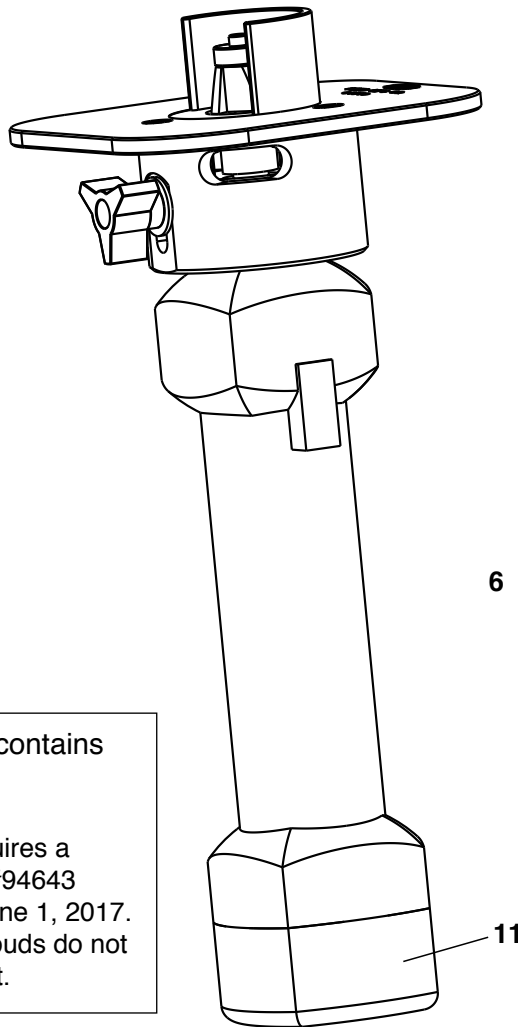

Retrofit Kit #44651 contains #44648 and #94643.

Router Bit #44648 requires a newer, plastic shroud #94643 for units sold before June 1, 2017. Original aluminum shrouds do not fit the #44648 router bit.

Parts List

Ref. No.	Description	Item Code	Qty.
1	ADAPTOR	94640	1
2	ADJUSTING RING	94641	1
3	GUIDE PLATE	94642	1
4a	O.D. SHROUD	94643	1
4b	I.D. SHROUD	94644	1
5a	5/8" ROUTER BIT	44644	1
5b	1" ROUTER BIT	44648	1
6	KNOB	35296	1
7	10-24 X 5/8 FHCS	35279	3
8	5/16 FLAT WASHER	30246	1
9	10-24 X 3/4 SHCS	35297	1
10	DIE GRINDER	44641	1
11*	4.0Ah BATTERY	98185	1
	2.0Ah BATTERY (optional)	98186	
12*	CHARGER (not shown)	98187	1

*Available at Bosch retailers

BOSCH® SKC181-101 18V Lithium-Ion Battery & Charger combination kit

Reed Manufacturing Company
1425 West 8th Street
Erie, PA 16502 USA

QUALITY
& Service
that Last a Lifetime

Phone: 800-666-3691 or 814-452-3691
Fax: 800-456-1697 or 814-455-1697
www.reedmfgco.com

RP-1019-131