

Optima® EAF-100

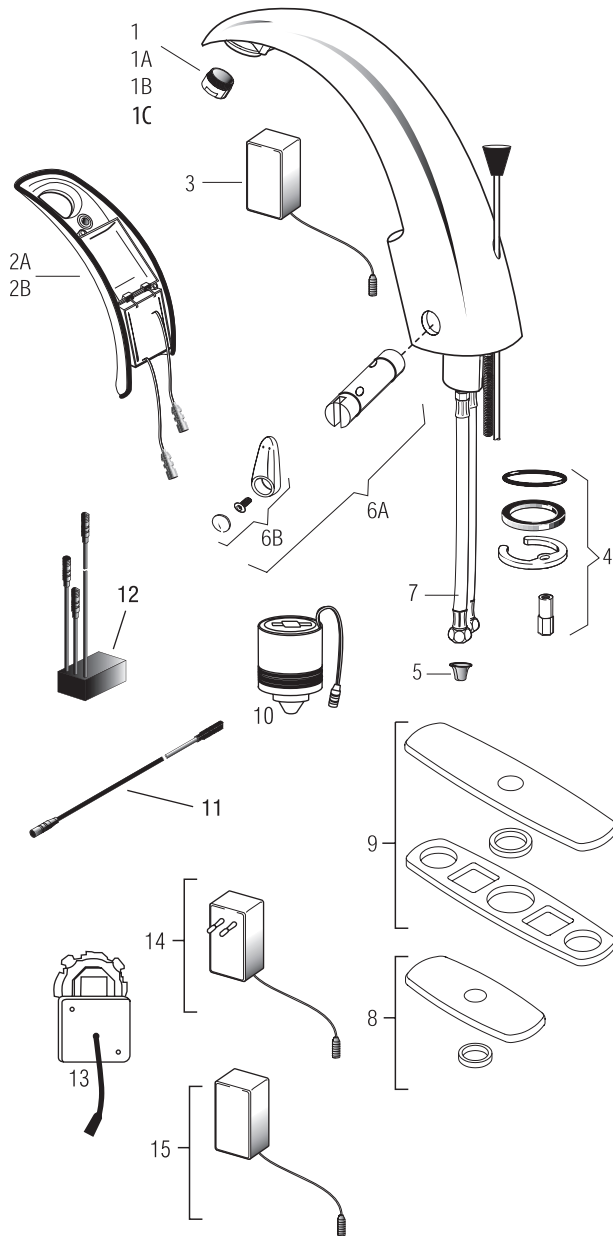

PARTS LIST—EAF-100 FAUCETS

Item No.	Code No.	Part No.	Description
1.	0335021	EAF-22	1.5 gpm (5.7 Lpm) Aerator Spray Head
1A.	0335008	EAF-10	2.2 gpm (8.3 Lpm) Aerator Spray Head
1B.	0335010	EAF-12	0.5 gpm (1.9 Lpm) Spray Head
1C.	0335029	EAF-51	0.35 gpm (1.3 Lpm) Spray Head (Multi-Lam)
2A.	0335004	EAF-6-A	Throat Plate Assembly (Plug-in Adapter Models)
2B.	0335005	EAF-7-A	Throat Plate Assembly with i.q.-cliq (Plug-in Adapter Model)
3.	0335009	EAF-11	90-264 VAC/6.75 VDC Plug-In Adapter (US)
4.	0335000	EAF-1	Faucet Mounting Kit
5.	0335007	EAF-9	Strainer (Filter)
6A.	3335118	EAF-1022-A	Side Mixer Cartridge & Handle
6B.	3335011	EAF-1002	Handle Repair Kit
7.	3335023	EAF-1008	13" (330 mm) Flexible Supply Hose
8.	3365302	ETF-607-A	Trim Plate for 4" Center-set Sink
9.	3365303	ETF-608-A	Trim Plate for 8" Center-set Sink
10.	0335001	EAF-2	Solenoid
11.	0335024	EAF-24-A	11-13/16" (300 mm) Extension Cable
	0335025	EAF-25-A	47-1/4" (1200 mm) Extension Cable
	0335015	EAF-17-A	126" (3200 mm) Extension Cable
12.†	—	EAF-44-A	Power Splitter†
13.	0335037	EAF-37	6 VDC Box Mount Adapter
14.	0335038	EAF-38	90-264 VAC/6.75 VDC Plug-In Adapter (EURO)
15.	0335039	EAF-39	90-264 VAC/6.75 VDC Plug-In Adapter (UK)

† EAF-44 replaces the separate EAF-23-A Splitter Cable and EAF-28 Capacitor, which is sold separately. EAF-1001 Mixer Handle Assembly and Cartridge prior to 2004 Discontinued

Electrical Connection for up to Six (6) Faucets Using One (1) Adapter

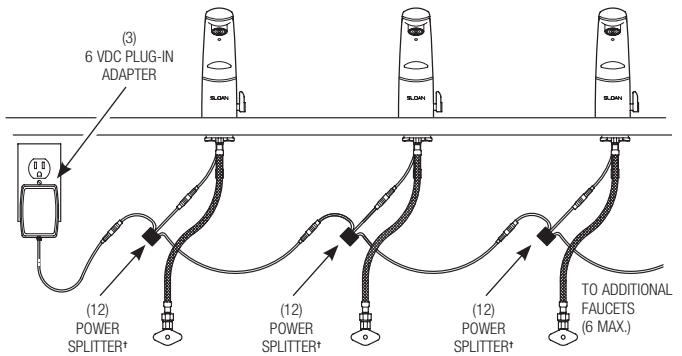

* EAF-100 faucets introduced in 2011 now require EAF-28-A Capacitor or EAF-44-A Power Splitter in ganging applications.

Optima® EAF-100*

AUTO RANGE ADJUSTMENT

Press button one (1) time, then immediately step away.

Faucet will run for four (4) seconds and the range will automatically adjust to its environment.

Wait ten (10) seconds after water shuts off before using faucet.

If faucet does not function, refer to the Troubleshooting section of this instruction manual.

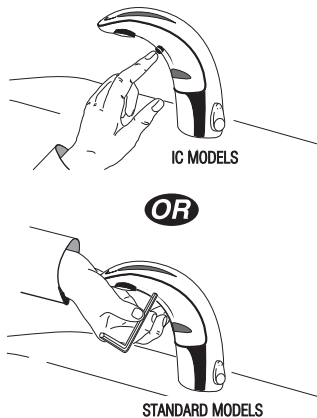

MANUAL RANGE ADJUSTMENT

Note: Use Manual range adjustment only when desired range cannot be obtained with auto range adjustment shown above.

Push button two (2) times (double click).

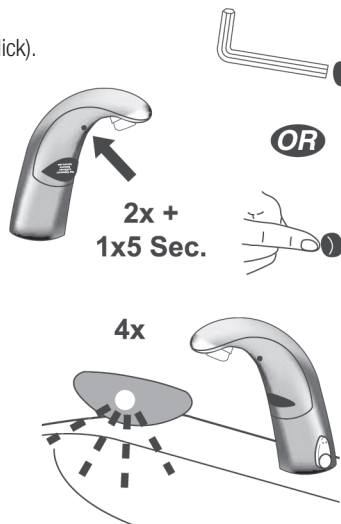

Push again and hold in button until LED flashes four (4) times, Then wait five (5) seconds,

Continue to hold button hold button in as Faucet continuously cycles through the following five (5) range settings.

- One (1) flash = shortest range**
- Two (2) flashes = short range**
- Three (3) flashes = medium range**
- Four (4) flashes = long range**
- Five (5) flashes = longest range**

Release button at desired setting. Then water will flow for four (4) seconds signaling confirmation of setting. Wait an additional ten (10) seconds before using Faucet.

Note: Updated electronics have visible red and green LED. Original electronics have only red LED and range setting is reversed (1=longest, 8=shortest)

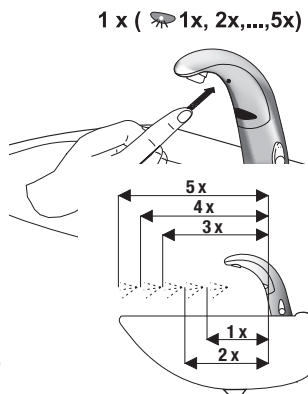

SERVICE OPERATION

Prepare for operation

A. Press the button once.

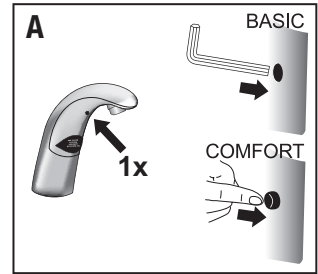

B. Remove sticker.



C. Water will flow 4 seconds



D. Wait 10 seconds, then the faucet is ready for use.



If waterflow doesn't start after removing the sticker and the red led within the sensor flashes continue with the following procedure!!

A. Press the button once.

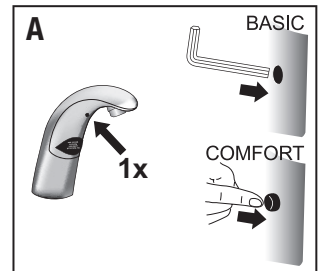

B. Hold a white sheet of paper 1.5" (40 mm) in front of sensor until water flows for 4 seconds

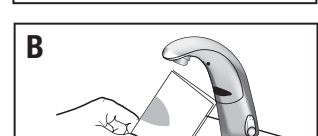

C. Remove paper.



D. Wait 10 seconds, then the faucet is ready for use.

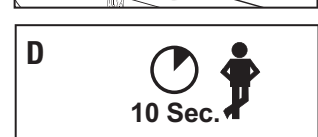

Optima® EAF-100

TROUBLESHOOTING GUIDE

1. Faucet DOES NOT function.

- A. Adhesive packaging label affixed over sensor eye. Remove adhesive label from sensor eye.
- B. "Permanent Off" activated. Press button on faucet throat one time.

2. Faucet delivers water in an uncontrolled manner.

- A. Faucet is not working properly. Contact Sloan Technical Support.

3. Faucet DOES NOT deliver any water when sensor is activated.

INDICATOR: Solenoid valve produces an audible "CLICK."

- A. Water supply stop(s) closed. Open water supply stop(s).
- B. Water supply stop strainer(s) clogged. Clean water supply stop strainer(s).

INDICATOR: Solenoid valve DOES NOT produce an audible "CLICK."

- A. Power failure (EAF-100 Models). Check power supply.

4. Faucet delivers only a slow flow or dribble when sensor is activated.

- A. Water supply stop(s) are partially closed. Completely open water supply stop(s).
- B. Water supply stop strainer(s) clogged. Remove, clean, and reinstall water supply stop strainer(s). Replace strainer(s) if required.
- C. Aerator is clogged. Remove, clean, and reinstall aerator. Replace aerator if required.
- D. Faucet is not working properly. Contact Sloan Technical Support.

5. Faucet DOES NOT stop delivering water or continues to drip after user is no longer detected.

- A. Faucet is not working properly. Contact Sloan Technical Support.

6. i.q.-cliq DOES NOT function (-IC models only)

- A. Button is not working properly. Contact Sloan Technical Support.

7. The water temperature is too hot or too cold on a faucet connected to hot and cold supply lines.

- A. Supply stops are not adjusted properly. Adjust supply stops.
- B. For models with integral mixing valve — mixing valve is set improperly for the water temperature desired. Rotate mixing valve handle clockwise to decrease water temperature or counterclockwise to increase water temperature.

DO NOT USE abrasive or chemical cleaners (including chlorine bleach) to

CARE AND CLEANING

clean faucets that may dull the luster and attack the chrome or special decorative finishes. Use **ONLY** mild soap and water, then wipe dry with clean cloth or towel.

While cleaning the bathroom tile, protect the faucet from any splattering of cleaner. Acids and cleaning fluids will discolor or remove chrome plating.

When assistance is required, please contact Sloan Technical Support at: 1-888-SLOAN-14 (1-888-756-2614).