

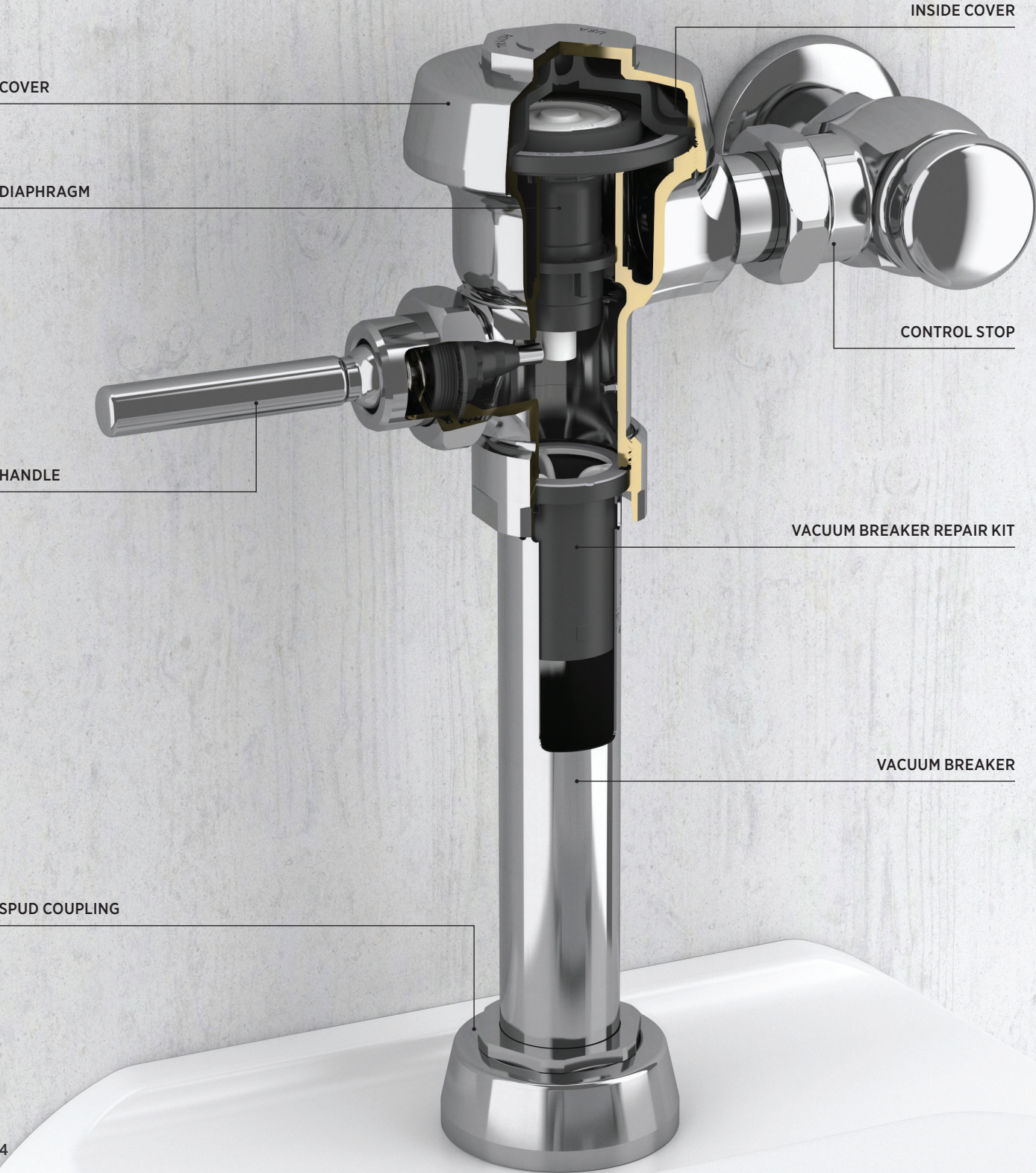









# Royal<sup>®</sup>

The first of its kind. The best in its class.



#### DIAPHRAGM ONLY KIT

	3301143	A-1050-A	0.125 gpf (0.5 Lpf)
	3301142	A-1047-A	0.25 gpf (1.0 Lpf)
	3301124	A-1043-A	0.5 gpf (1.9 Lpf)
	3301123	A-1042-A	1.0 gpf (3.8 Lpf)
	3301119	A-1045-A	1.28 gpf (4.8 Lpf)
	3301120	A-1037-A	1.5 gpf (5.7 Lpf)
	3301122	A-1041-A	1.6 gpf (6.0 Lpf)
	3301125	A-1044-A	2.4 gpf (9.0 Lpf)
	3301121	A-1038-A	3.5 gpf (13.2 Lpf)

#### ROYAL COVER

	0301172PK	A-72
--	-----------	------

#### INSIDE COVER

	0301168	A-71
---	---------	------

\* For use with 3/4" H-600-A BAK-CHEK® screwdriver control stop for urinals only (1964-1994).

\*\* For use with 3/4" and 1" H-700-A BAK-CHEK screwdriver control stops (1995-present) or 1" H-600-A BAK-CHEK screwdriver control stop (1964-1994).

#### CONTROL STOP REPAIR KIT

	3308856*	H-543-ASD	3/4" (19 mm)
	3308853**	H-541-ASD	1" (25 mm)

#### VACUUM BREAKER REPAIR KIT

	3323183	V-651-A
---	---------	---------

#### VACUUM BREAKER

	3393004	V-600-AA	3/4" x 9" (19 x 229 mm)
	3393006	V-600-AA	1 1/4" x 9" (32 x 229 mm)
	3393007	V-600-AA	1 1/2" x 9" (38 x 229 mm)

#### SPUD COUPLING ASSEMBLY

	0306125	F-5-AW	3/4" (19 mm)
	0306140	F-5-AU	1 1/4" (32 mm)
	0306146	F-5-AT	1 1/2" (38 mm)

#### HANDLE

	3302003	B-51-A	Handle Repair Kit
	0302390	B-73-A	ADA Handle



### Royal® Performance Kit

Includes dual-filtered fixed bypass diaphragm assembly, handle repair kit with triple seal packing, high back pressure vacuum breaker repair kit, and tailpiece o-ring.

3301073	A-1106-A	0.5 gpf (1.9 Lpf)	Urinals
3301070	A-1101-A	1.6 gpf (6.0 Lpf)	Water Closets



### Royal® Tune Up Kit

Includes everything in the Royal Performance Kit with the addition of an inside cover.

3301188	A-1126-A	0.5 gpf (1.9 Lpf)	Urinals
3301184	A-1121-A	1.6 gpf (6.0 Lpf)	Water Closets