

# STRYKE™

Models/Modelos/Modèles  
9176T-DST & 9976T-DST

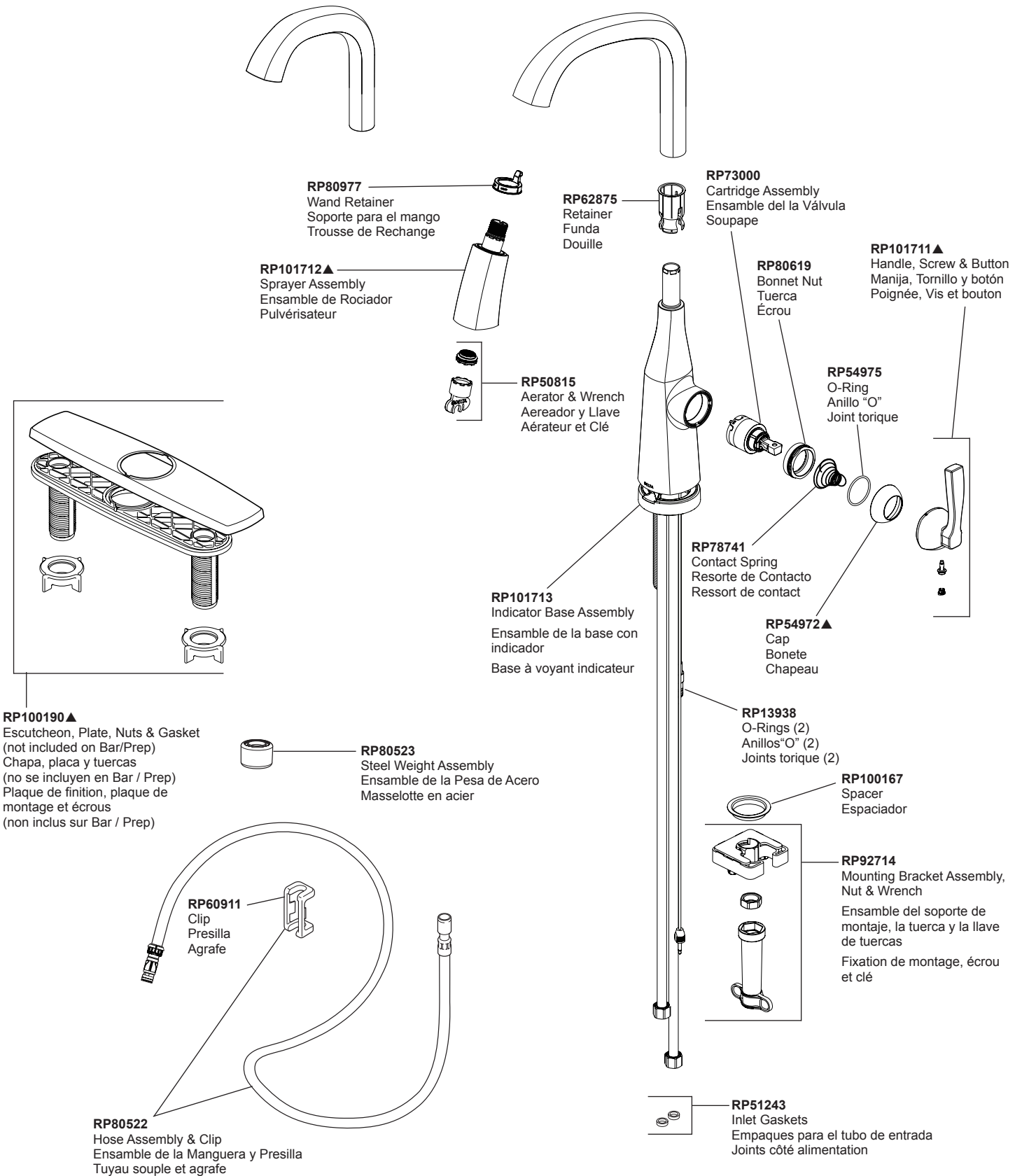

▲Specify Finish / Especificque el Acabado / Précisez le Fini

**STRYKE™**  
**Models/Modelos/Modèles**  
**9176T-DST & 9976T-DST**

**EP92546**

Solenoid Assembly  
 Ensemble de Solenoïde  
 Electrovanne

For PC, SS, AR & KS finishes, order **EP92546**  
 For BL, MW, RB & SP finishes, order **EP92546XX**

Para acabados PC, SS, AR y KS, ordene **EP92546**  
 Para acabados BL, MW, RB y SP, ordene **EP92546XX**

Pour les finis PC, SS, AR et KS, commandez **EP92546**  
 Pour les finis BL, MW, RB et SP, commandez **EP92546XX**

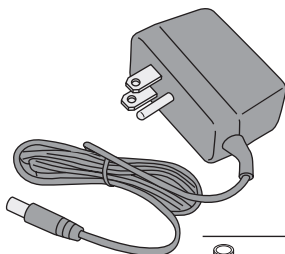

**EP73954**

9 Volt Power Supply  
 (Accessory Order Only)  
 Fuente de alimentación de 9 voltios  
 (Orden de accesorios solamente)  
 Alimentation électrique 9 volts  
 (L'accessoire seulement)

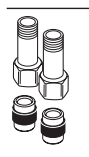

**RP53468**

Check Valves  
 Válvulas Checadoras  
 Clapets de non-retour



**RP50952**

Cut-To-Fit Plastic Sleeves  
 Casquillos cortados a la medida  
 Bagues d'extrémité pour tubes coupés

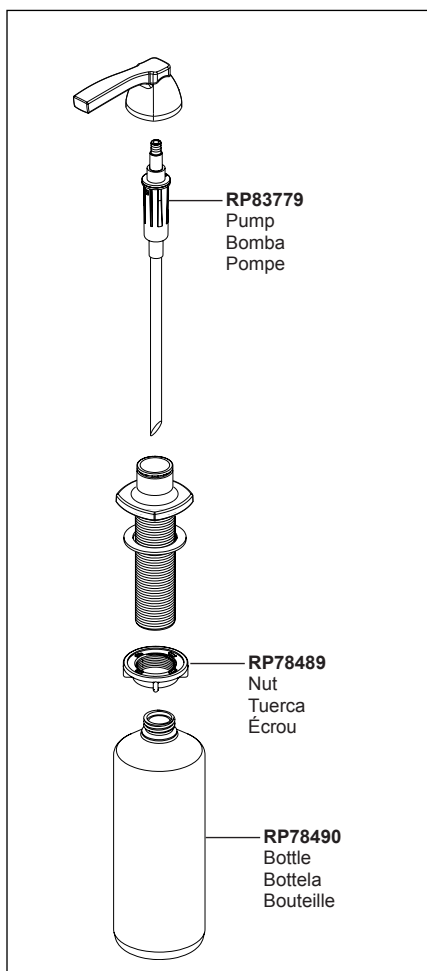

**RP83779**

Pump  
 Bomba  
 Pompe

**RP78489**

Nut  
 Tuerca  
 Écrou

**RP78490**

Bottle  
 Bottella  
 Bouteille

**RP101629▲**

Dispenser Assembly  
 Ensemble del Dispensador  
 Distributeur

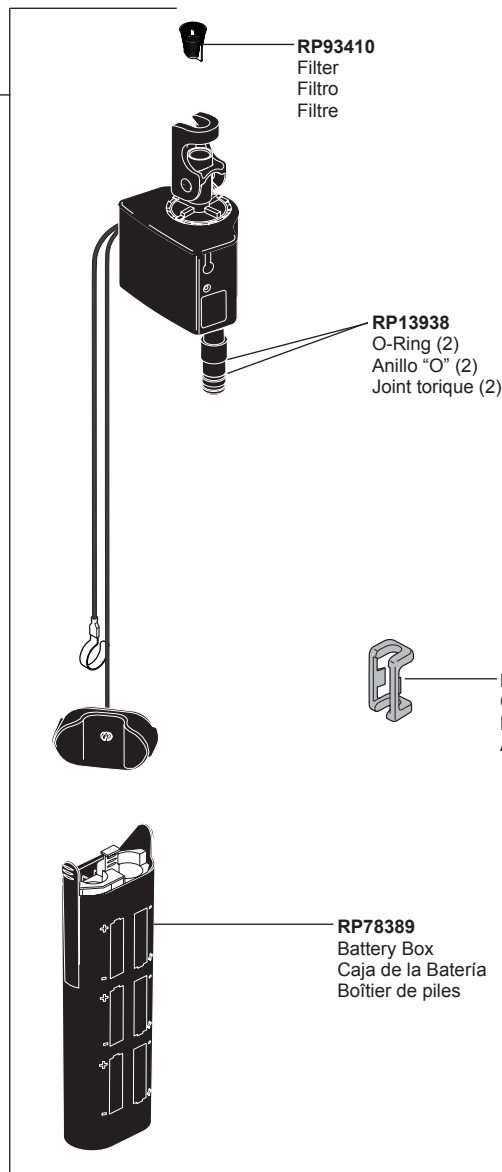

**RP93410**

Filter  
 Filtro  
 Filtre

**RP13938**

O-Ring (2)  
 Anillo "O" (2)  
 Joint torique (2)

**RP60911**

Clip  
 Presilla  
 Agrafe

**RP78389**

Battery Box  
 Caja de la Bateria  
 Boîtier de piles

Other useful accessories that may be purchased separately.  
 Otros accesorios útiles que se pueden comprar por separado.  
 Autres accessoires utiles pouvant être achetés séparément.

**RP63263**

Adapters  
 3/8"-24 UNEF to 1/2"-20 UN &  
 3/8"-24 UNEF to 1/2"-14 NPSM  
 Adaptadors  
 3/8"-24 UNEF a 1/2"-20 UN &  
 3/8"-24 UNEF a 1/2"-14 NPSM  
 Adapteurs  
 3/8 po-24 UNEF à 1/2 po-20 UN et  
 3/8 po-24 UNEF à 1/2 po-14 NPSM

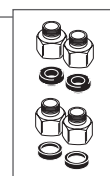

**RP63264**

Adapters (10) 3/8"-24 UNEF to 1/2"-20 UN  
 Adaptadors (10) 3/8"-24 UNEF a 1/2"-20 UN  
 Adpteurs (10) 3/8 po-24 UNEF à 1/2 po-20 UN

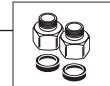

**RP63265**

Adapters (10) 3/8"-24 UNEF to 1/2"-14 NPSM  
 Adaptadors (10) 3/8"-24 UNEF a 1/2"-14 NPSM  
 Adpteurs (10) 3/8 po-24 UNEF à 1/2 po-14 NPSM

