

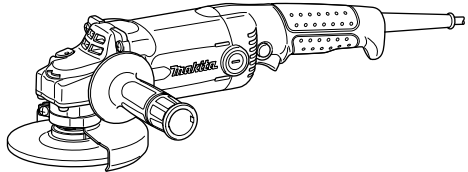

INSTRUCTION MANUAL
MANUEL D'INSTRUCTION
MANUAL DE INSTRUCCIONES

Angle Grinder Meuleuse d'Angle Esmeriladora de Disco

GA5020
GA5020C
GA5020Y
GA5021C
GA6020
GA6020C
GA6020Y



008074



DOUBLE INSULATION
DOUBLE ISOLATION
DOBLE AISLAMIENTO

IMPORTANT: Read Before Using.
IMPORTANT: Lire avant usage.
IMPORTANTE: Leer antes de usar.

ENGLISH (Original instructions)

SPECIFICATIONS

Model	GA5020,/GA5020Y	GA5020C/GA5021C	GA6020/GA6020Y	GA6020C
Wheel diameter	125 mm (5")	125 mm (5")	150 mm (6")	150 mm (6")
Spindle thread	5/8"			
No load speed (RPM)	11,000/min	10,000/min	10,000/min	9,000/min
Overall length	356 mm (14")	390mm (15-3/8")	356 mm (14")	390mm (15-3/8")
Net weight	2.7 kg (5.9 lbs)	2.9 Kg (6.4 lbs)	3.0 kg (6.7 lbs)	3.0 kg (6.6 lbs)

- Due to our continuing program of research and development, the specifications herein are subject to change without notice.
- Specifications may differ from country to country.
- Weight according to EPTA-Procedure 01/2003

GEA008-2

General Power Tool Safety

Warnings

⚠ WARNING Read all safety warnings and all instructions. Failure to follow the warnings and instructions may result in electric shock, fire and/or serious injury.

Save all warnings and instructions for future reference.

The term "power tool" in the warnings refers to your mains-operated (corded) power tool or battery-operated (cordless) power tool.

Work area safety

1. **Keep work area clean and well lit.** Cluttered or dark areas invite accidents.
2. **Do not operate power tools in explosive atmospheres, such as in the presence of flammable liquids, gases or dust.** Power tools create sparks which may ignite the dust or fumes.
3. **Keep children and bystanders away while operating a power tool.** Distractions can cause you to lose control.

Electrical Safety

4. **Power tool plugs must match the outlet. Never modify the plug in any way. Do not use any adapter plugs with earthed (grounded) power tools.** Unmodified plugs and matching outlets will reduce risk of electric shock.
5. **Avoid body contact with earthed or grounded surfaces such as pipes, radiators, ranges and refrigerators.** There is an increased risk of electric shock if your body is earthed or grounded.
6. **Do not expose power tools to rain or wet conditions.** Water entering a power tool will increase the risk of electric shock.
7. **Do not abuse the cord. Never use the cord for carrying, pulling or unplugging the power tool. Keep cord away from heat, oil, sharp edges or**

moving parts. Damaged or entangled cords increase the risk of electric shock.

8. **When operating a power tool outdoors, use an extension cord suitable for outdoor use.** Use of a cord suitable for outdoor use reduces the risk of electric shock.
9. **If operating a power tool in a damp location is unavoidable, use a ground fault circuit interrupter (GFCI) protected supply.** Use of an GFCI reduces the risk of electric shock.

Personal Safety

10. **Stay alert, watch what you are doing and use common sense when operating a power tool. Do not use a power tool while you are tired or under the influence of drugs, alcohol or medication.** A moment of inattention while operating power tools may result in serious personal injury.
11. **Use personal protective equipment. Always wear eye protection.** Protective equipment such as dust mask, non-skid safety shoes, hard hat, or hearing protection used for appropriate conditions will reduce personal injuries.
12. **Prevent unintentional starting. Ensure the switch is in the off-position before connecting to power source and/or battery pack, picking up or carrying the tool.** Carrying power tools with your finger on the switch or energising power tools that have the switch on invites accidents.
13. **Remove any adjusting key or wrench before turning the power tool on.** A wrench or a key left attached to a rotating part of the power tool may result in personal injury.
14. **Do not overreach. Keep proper footing and balance at all times.** This enables better control of the power tool in unexpected situations.
15. **Dress properly. Do not wear loose clothing or jewellery. Keep your hair, clothing, and gloves away from moving parts.** Loose clothes, jewellery or long hair can be caught in moving parts.

16. **If devices are provided for the connection of dust extraction and collection facilities, ensure these are connected and properly used.** Use of dust collection can reduce dust-related hazards.

Power tool use and care

17. **Do not force the power tool. Use the correct power tool for your application.** The correct power tool will do the job better and safer at the rate for which it was designed.
18. **Do not use the power tool if the switch does not turn it on and off.** Any power tool that cannot be controlled with the switch is dangerous and must be repaired.
19. **Disconnect the plug from the power source and/or the battery pack from the power tool before making any adjustments, changing accessories, or storing power tools.** Such preventive safety measures reduce the risk of starting the power tool accidentally.
20. **Store idle power tools out of the reach of children and do not allow persons unfamiliar with the power tool or these instructions to operate the power tool.** Power tools are dangerous in the hands of untrained users.
21. **Maintain power tools. Check for misalignment or binding of moving parts, breakage of parts and any other condition that may affect the power tool's operation. If damaged, have the**

power tool repaired before use. Many accidents are caused by poorly maintained power tools.

22. **Keep cutting tools sharp and clean.** Properly maintained cutting tools with sharp cutting edges are less likely to bind and are easier to control.
23. **Use the power tool, accessories and tool bits etc. in accordance with these instructions, taking into account the working conditions and the work to be performed.** Use of the power tool for operations different from those intended could result in a hazardous situation.

Service

24. **Have your power tool serviced by a qualified repair person using only identical replacement parts.** This will ensure that the safety of the power tool is maintained.
25. **Follow instruction for lubricating and changing accessories.**
26. **Keep handles dry, clean and free from oil and grease.**

USE PROPER EXTENSION CORD. Make sure your extension cord is in good condition. When using an extension cord, be sure to use one heavy enough to carry the current your product will draw. An undersized cord will cause a drop in line voltage resulting in loss of power and overheating. Table 1 shows the correct size to use depending on cord length and nameplate ampere rating. If in doubt, use the next heavier gage. The smaller the gage number, the heavier the cord.

Table 1: Minimum gage for cord

Ampere Rating		Volts	Total length of cord in feet			
		120V	25 ft.	50 ft.	100 ft.	150 ft.
		220V - 240V	50 ft.	100 ft.	200 ft.	300 ft.
More Than	Not More Than	AWG				
0	6	/	18	16	16	14
6	10		18	16	14	12
10	12		16	16	14	12
12	16		14	12	Not Recommended	

000300

USB005-4

SPECIFIC SAFETY RULES

DO NOT let comfort or familiarity with product (gained from repeated use) replace strict adherence to grinder safety rules. If you use this tool unsafely or incorrectly, you can suffer serious personal injury.

- Always use proper guard with grinding wheel.** A guard protects operator from broken wheel fragments.
- Accessories must be rated for at least the speed recommended on the tool warning label.** Wheels and other accessories running over rated speed can fly apart and cause injury.
- Hold tool by insulated gripping surfaces when performing an operation where the cutting tool may contact hidden wiring or its own cord.**

- Contact with a "live" wire will make exposed metal parts of the tool "live" and shock the operator.
4. **When using depressed center grinding wheels, be sure to use only fiberglass-reinforced wheels.**
 5. **Always use safety glasses or goggles. Ordinary eye or sun glasses are NOT safety glasses.**
 6. **Check the wheel carefully for cracks or damage before operation. Replace cracked or damaged wheel immediately. Run the tool (with guard) at no load for about a minute, holding tool away from others. If wheel is flawed, it will likely separate during this test.**
 7. **Use only flanges specified for this tool.**
 8. **Be careful not to damage the spindle, the flange (especially the installing surface) or the lock nut. Damage to these parts could result in wheel breakage.**
 9. **NEVER use tool with wood cutting blades or other sawblades. Such blades when used on a grinder frequently kick and cause loss of control leading to personal injury.**
 10. **Hold the tool firmly.**
 11. **Keep hands away from rotating parts.**
 12. **Make sure cord is clear of wheel. Do not wrap cord around your arm or wrist. If control of tool is lost, cord may become wrapped around you and cause personal injury.**
 13. **Make sure the wheel is not contacting the workpiece before the switch is turned on.**
 14. **Before using the tool on an actual workpiece, let it run for a while. Watch for vibration or wobbling that could indicate poor installation or a poorly balanced wheel.**
 15. **Use the specified surface of the wheel to perform the grinding.**
 16. **Watch out for flying sparks. Hold the tool so that sparks fly away from you and other persons or flammable materials.**
 17. **Do not leave the tool running. Operate the tool only when hand-held.**
 18. **Do not touch the workpiece immediately after operation; it may be extremely hot and could burn your skin.**
 19. **ALWAYS wear proper apparel including long sleeve shirts, leather gloves and shop aprons to protect skin from contact with hot grindings.**
 20. **Use of this tool to grind or sand some products, paints and wood could expose user to dust containing hazardous substances. Use appropriate respiratory protection.**

21. **After using the tool, make sure the wheel rotation comes to a complete stop before setting the tool down. Setting the tool down with the wheel rotating can cause personal injury.**

SAVE THESE INSTRUCTIONS.





WARNING:

MISUSE or failure to follow the safety rules stated in this instruction manual may cause serious personal injury.

USD295-1

Symbols

The followings show the symbols used for tool.

	· volts
	· amperes
	· alternating current
	· alternating or direct current
n_0	· no load speed
	· Class II Construction
\dots / min r / min	· revolutions or reciprocation per minute

FUNCTIONAL DESCRIPTION

⚠CAUTION:

- Always be sure that the tool is switched off and unplugged before adjusting or checking function on the tool.

Shaft lock

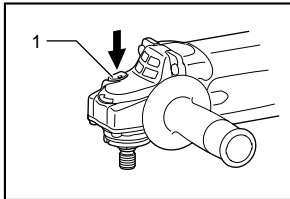

007991

1. Shaft lock

⚠CAUTION:

- Never actuate the shaft lock when the spindle is moving. The tool may be damaged.

Press the shaft lock to prevent spindle rotation when installing or removing accessories.

Switch action

⚠CAUTION:

- Before plugging in the tool, always check to see that the switch trigger actuates properly and returns to the "OFF" position when released.

For tool with type A switch trigger

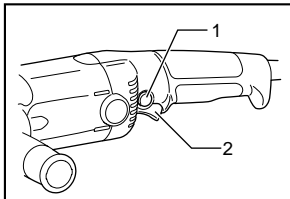

007992

1. Lock button /
Lock-off button
2. Switch trigger
(typeA)

For tool without lock button and lock-off button

To start the tool, simply pull the switch trigger. Release the switch trigger to stop.

For tool with lock-off button

To prevent the switch trigger from being accidentally pulled, a lock-off button is provided.

To start the tool, depress the lock-off button and pull the switch trigger. Release the switch trigger to stop.

For tool with typeB switch trigger

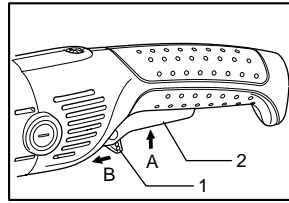

008415

1. Lock lever
2. Switch trigger

For tool with the lock-on switch

To start the tool, simply pull the switch trigger (A). Release the switch trigger to stop. For continuous operation, pull the switch trigger (A) and then push in the lock lever (B). To stop the tool from the locked position, pull the switch trigger (A) fully, then release it.

For tool with the lock-off switch

To prevent the switch trigger from accidentally pulled, a lock lever is provided. To start the tool, push in the lock lever (B) and then pull the switch trigger (A). Release the switch trigger to stop.

For tool with the lock on and lock-off switch

To prevent the switch trigger from accidentally pulled, a lock lever is provided. To start the tool, push in the lock lever (B) and then pull the switch trigger (A). Release the switch trigger to stop. For continuous operation, push in the lock lever (B), pull the switch trigger and then push the lock lever further in (B). To stop the tool from the locked position, pull the switch trigger (A) fully, then release it.

Electronic function

Constant speed control (For models GA5020C/GA5021C/GA6020C)

- Possible to get fine finish, because the rotating speed is kept constantly even under the loaded condition.
- Additionally, when the load on the tool exceeds admissible levels, power to the motor is reduced to protect the motor from overheating. When the load returns to admissible levels, the tool will operate as normal.

Soft start feature

- Soft start because of suppressed starting shock.

Indication lamp

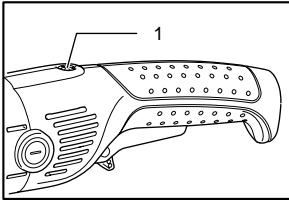

1. Indication lamp

008416

The indication lamp lights up green when the tool is plugged. If the indication lamp does not light up, the mains cord or the controller may be defective. The indication lamp is lit but the tool does not start even if the tool is switched on, the carbon brushes may be worn out, or the controller, the motor or the ON/OFF switch may be defective.

Unintentional restart proof

Even locking lever keeping the switch trigger depressed (Lock-on position) does not allow the tool to restart even when the tool is plugged.

At this time, the indication lamp flickers red and shows the unintentional restart proof device is on function.

To cancel the unintentional restart proof, pull the switch trigger fully, then release it.

ASSEMBLY

⚠CAUTION:

- Always be sure that the tool is switched off and unplugged before carrying out any work on the tool.

Installing side grip (handle)

⚠CAUTION:

- Always be sure that the side grip is installed securely before operation.

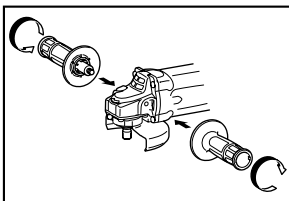

007993

Screw the side grip securely on the position of the tool as shown in the figure.

Installing loop handle (Accessory)

⚠CAUTION:

- Always be sure that the loop handle is installed securely before operation.

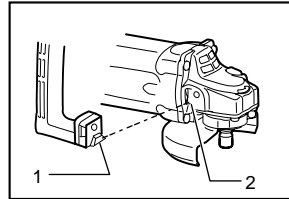

008049

Always install the loop handle on the tool before operation. Hold the tool's switch handle and the loop handle firmly with both hands during operation.

Install the loop handle so that its protrusion will fit into the matching hole in the gear housing.

Install the bolts and tighten them with the hex wrench. The loop handle can be installed in two different directions as shown in the figures whichever is convenient for your work.

1. Protrusion of loop handle
2. Matching hole in gear housing

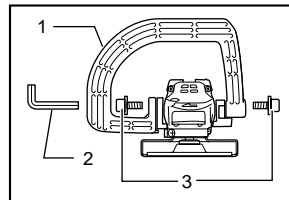

008047

1. Loop handle
2. Hex wrench
3. Bolt

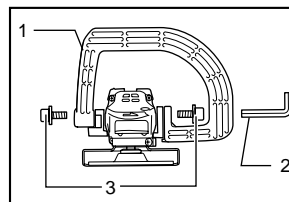

008048

1. Loop handle
2. Hex wrench
3. Bolt

Installing or removing wheel guard

⚠CAUTION:

- When using a depressed center grinding wheel/Multi-disc, wire wheel brush or cut-off wheel, the wheel guard must be fitted on the tool so that the closed side of the guard always points toward the operator.

For tool with locking screw type wheel guard

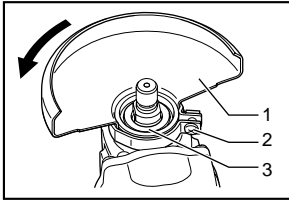

1. Wheel guard
2. Screw
3. Bearing box

007994

Mount the wheel guard with the protrusion on the wheel guard band aligned with the notch on the bearing box. Then rotate the wheel guard around 180 degrees counterclockwise. Be sure to tighten the screw securely. To remove wheel guard, follow the installation procedure in reverse.

For tool with clamp lever type wheel guard

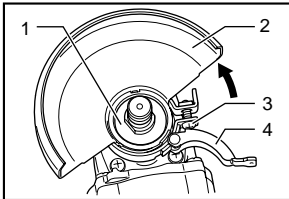

1. Bearing box
2. Wheel guard
3. Screw
4. Lever

008343

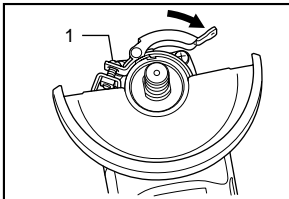

1. Screw

008344

Loosen the lever on the wheel guard after loosening the screw. Mount the wheel guard with the protrusion on the wheel guard band aligned with the notch on the bearing box. Then rotate the wheel guard around to the position shown in the figure. Tighten the lever to fasten the wheel guard. If the lever is too tight or too loose to fasten the wheel guard, loosen or tighten the screw to adjust the tightening of the wheel guard band.

To remove wheel guard, follow the installation procedure in reverse.

Installing or removing depressed center grinding wheel/Multi-disc (accessory)

⚠WARNING:

- Always use supplied guard when depressed center grinding wheel/Multi-disc is on tool. Wheel can shatter during use and guard helps to reduce chances of personal injury.

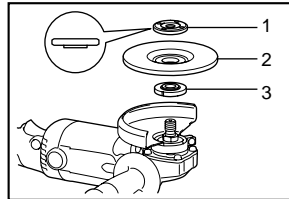

1. Lock nut
2. Depressed center grinding wheel/Multi-disc
3. Inner flange

007995

For USA/Canada 6" Grinders

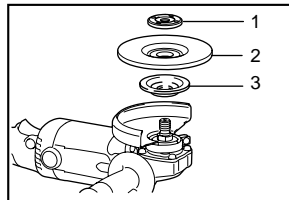

1. Lock nut
2. Depressed center grinding wheel/Multi-disc
3. Inner flange

008053

Mount the inner flange onto the spindle. Fit the wheel/disc on the inner flange and screw the lock nut onto the spindle.

To tighten the lock nut, press the shaft lock firmly so that the spindle cannot revolve, then use the lock nut wrench and securely tighten clockwise.

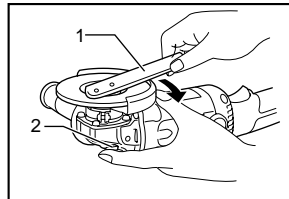

1. Lock nut wrench
2. Shaft lock

007996

To remove the wheel, follow the installation procedure in reverse.

Installing or removing abrasive disc (optional accessory)

NOTE:

- Use sander accessories specified in this manual. These must be purchased separately.

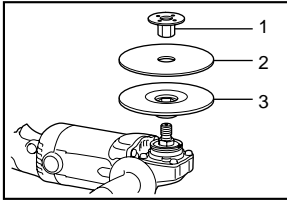

1. Lock nut
2. Abrasive disc
3. Rubber pad

007997

Mount the rubber pad onto the spindle. Fit the disc on the rubber pad and screw the lock nut onto the spindle. To tighten the lock nut, press the shaft lock firmly so that the spindle cannot revolve, then use the lock nut wrench and securely tighten clockwise.

To remove the disc, follow the installation procedure in reverse.

OPERATION

⚠WARNING:

- It should never be necessary to force the tool. The weight of the tool applies adequate pressure. Forcing and excessive pressure could cause dangerous wheel breakage.
- ALWAYS replace wheel if tool is dropped while grinding.
- NEVER bang or hit grinding disc or wheel onto work.
- Avoid bouncing and snagging the wheel, especially when working corners, sharp edges etc. This can cause loss of control and kickback.
- NEVER use tool with wood cutting blades and other sawblades. Such blades when used on a grinder frequently kick and cause loss of control leading to personal injury.

⚠CAUTION:

- Never switch on the tool when it is in contact with the workpiece, it may cause an injury to operator.
- Always wear safety goggles or a face shield during operation.
- After operation, always switch off the tool and wait until the wheel has come to a complete stop before putting the tool down.

Grinding and sanding operation

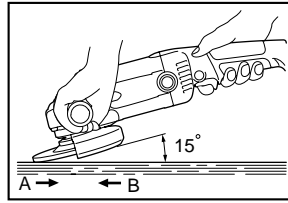

007998

ALWAYS hold the tool firmly with one hand on rear handle and the other on the side handle. Turn the tool on and then apply the wheel or disc to the workpiece.

In general, keep the edge of the wheel or disc at an angle of about 15 degrees to the workpiece surface.

During the break-in period with a new wheel, do not work the grinder in the B direction or it will cut into the workpiece. Once the edge of the wheel has been rounded off by use, the wheel may be worked in both A and B direction.

Operation with wire cup brush (optional accessory)

⚠CAUTION:

- Check operation of brush by running tool with no load, insuring that no one is in front of or in line with brush.
- Do not use brush that is damaged, or which is out of balance. Use of damaged brush could increase potential for injury from contact with broken brush wires.

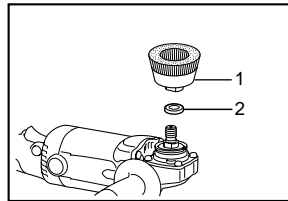

1. Wire cup brush
2. Urethane washer

008002

Unplug tool and place it upside down allowing easy access to spindle. Remove any accessories on spindle. Mount urethane washer then thread wire cup brush onto spindle and tighten with supplied wrench. When using brush, avoid applying too much pressure which causes over bending of wires, leading to premature breakage.

NOTE:

- When using wire cup brush, mount urethane washer to the spindle. It will make it easier to remove wire cup brush.

Operation with wire wheel brush (optional accessory)

⚠CAUTION:

- Check operation of wire wheel brush by running tool with no load, insuring that no one is in front of or in line with the wire wheel brush.
- Do not use wire wheel brush that is damaged, or which is out of balance. Use of damaged wire wheel brush could increase potential for injury from contact with broken wires.
- ALWAYS use guard with wire wheel brushes, assuring diameter of wheel fits inside guard. Wheel can shatter during use and guard helps to reduce chances of personal injury.

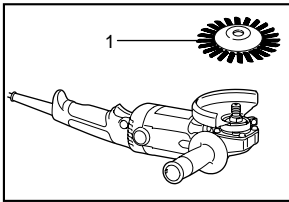

1. Wire wheel brush

007999

Unplug tool and place it upside down allowing easy access to spindle. Remove any accessories on spindle. Thread wire wheel brush onto spindle and tighten with the wrenches.

When using wire wheel brush, avoid applying too much pressure which causes over bending of wires, leading to premature breakage.

Operation with abrasive cut-off wheel (optional accessory)

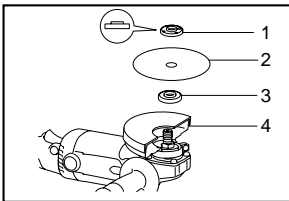

1. Lock nut
2. Abrasive cut-off wheel
3. Inner flange
4. Wheel guard for cut-off wheel

008054

⚠WARNING:

- When using an abrasive cut-off wheel, be sure to use only the special wheel guard designed for use with cut-off wheels.
- NEVER use cut-off wheel for side grinding.
- Do not "jam" the wheel or apply excessive pressure. Do not attempt to make an excessive depth of cut. Overstressing the wheel increases the loading and susceptibility to twisting or binding of the wheel in the cut and the possibility of

kickback, wheel breakage and overheating of the motor may occur.

- Do not start the cutting operation in the workpiece. Let the wheel reach full speed and carefully enter into the cut moving the tool forward over the workpiece surface. The wheel may bind, walk up or kickback if the power tool is started in the workpiece.
- During cutting operations, never change the angle of the wheel. Placing side pressure on the cut-off wheel (as in grinding) will cause the wheel to crack and break, causing serious personal injury.

MAINTENANCE

⚠CAUTION:

- Always be sure that the tool is switched off and unplugged before attempting to perform inspection or maintenance.
- Never use gasoline, benzine, thinner, alcohol or the like. Discoloration, deformation or cracks may result.

The tool and its air vents have to be kept clean. Regularly clean the tool's air vents or whenever the vents start to become obstructed.

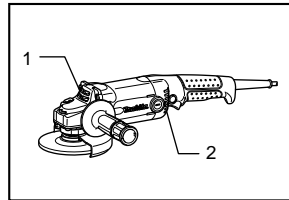

1. Exhaust vent
2. Inhalation vent

008001

Replacing carbon brushes

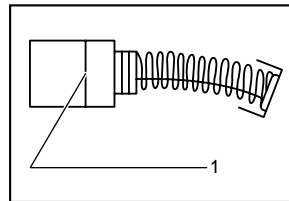

1. Limit mark

001145

Remove and check the carbon brushes regularly. Replace when they wear down to the limit mark. Keep the carbon brushes clean and free to slip in the holders. Both carbon brushes should be replaced at the same time. Use only identical carbon brushes.

Use a screwdriver to remove the brush holder caps. Take out the worn carbon brushes, insert the new ones and secure the brush holder caps.

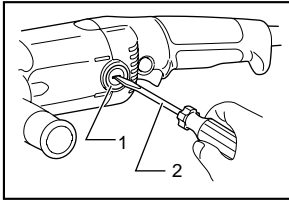

1. Brush holder cap
2. Screwdriver

008000

To maintain product SAFETY and RELIABILITY, repairs, any other maintenance or adjustment should be performed by Makita Authorized or Factory Service Centers, always using Makita replacement parts.

OPTIONAL ACCESSORIES

⚠CAUTION:

- These accessories or attachments are recommended for use with your Makita tool specified in this manual. The use of any other accessories or attachments might present a risk of injury to persons. Only use accessory or attachment for its stated purpose.
- Your tool is supplied with a guard for use with a depressed center grinding wheel, multi-disc and wire wheel brush. A cut-off wheel can also be used with an optional guard. If you decide to use your Makita grinder with approved accessories which you purchase from your Makita distributor or factory service center, be sure to obtain and use all necessary fasteners and guards as recommended in this manual. Your failure to do so could result in personal injury to you and others.

If you need any assistance for more details regarding these accessories, ask your local Makita Service Center.

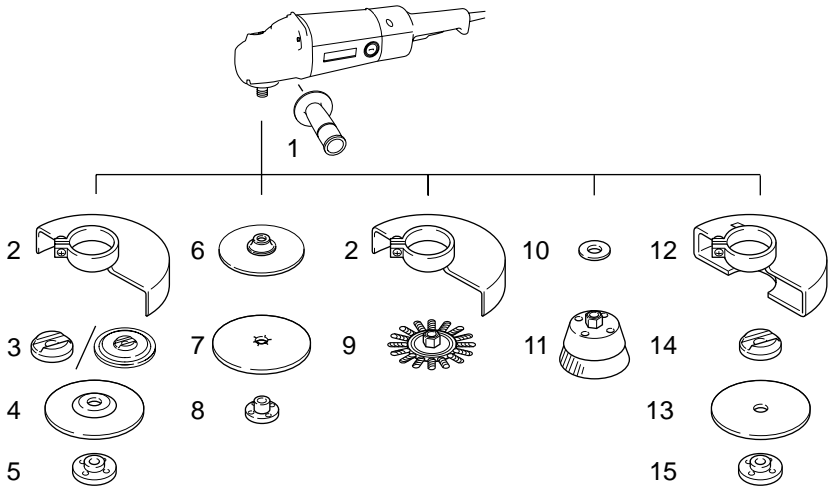

	GA5020/GA5020C/GA5021C/GA5020Y	GA6020/GA6020C/GA6020Y
1	Grip 36	
2	Wheel guard	
3	Inner flange 45	Inner flange 82
4	Depressed center grinding wheel/Multi-disc	
5	Lock nut 5/8-45	
6	Rubber pad 115	
7	Abrasive disc	
8	Sanding lock nut 5/8-48	
9	Wire wheel brush	
10	Urethane washer 14	
11	Wire cup brush	
12	Wheel guard (For cut-off wheel)	
13	Cut-off wheel	
14	Inner flange 45	Inner flange 48
15	Lock nut 5/8-45	Lock nut 5/8-48
-	Lock nut wrench 28	
-	Loop handle	
-	Dust cover	

008055

NOTE:

- Some items in the list may be included in the tool package as standard accessories. They may differ from country to country.

MAKITA LIMITED ONE YEAR WARRANTY

Warranty Policy

Every Makita tool is thoroughly inspected and tested before leaving the factory. It is warranted to be free of defects from workmanship and materials for the period of ONE YEAR from the date of original purchase. Should any trouble develop during this one year period, return the COMPLETE tool, freight prepaid, to one of Makita's Factory or Authorized Service Centers. If inspection shows the trouble is caused by defective workmanship or material, Makita will repair (or at our option, replace) without charge.

This Warranty does not apply where:

- repairs have been made or attempted by others:
- repairs are required because of normal wear and tear:
- the tool has been abused, misused or improperly maintained:
- alterations have been made to the tool.

IN NO EVENT SHALL MAKITA BE LIABLE FOR ANY INDIRECT, INCIDENTAL OR CONSEQUENTIAL DAMAGES FROM THE SALE OR USE OF THE PRODUCT. THIS DISCLAIMER APPLIES BOTH DURING AND AFTER THE TERM OF THIS WARRANTY.

MAKITA DISCLAIMS LIABILITY FOR ANY IMPLIED WARRANTIES, INCLUDING IMPLIED WARRANTIES OF "MERCHANTABILITY" AND "FITNESS FOR A SPECIFIC PURPOSE," AFTER THE ONE YEAR TERM OF THIS WARRANTY.

This Warranty gives you specific legal rights, and you may also have other rights which vary from state to state. Some states do not allow the exclusion or limitation of incidental or consequential damages, so the above limitation or exclusion may not apply to you. Some states do not allow limitation on how long an implied warranty lasts, so the above limitation may not apply to you.

EN0006-1