

Light and Mirror

LM 9771

Installation instructions

A mm	A inch	B mm	B inch
800	31 1/2"	524	20 5/8"

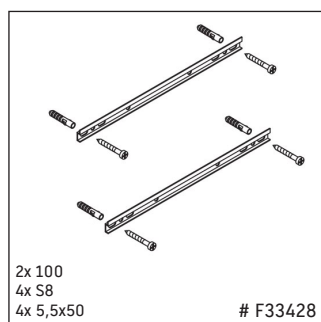
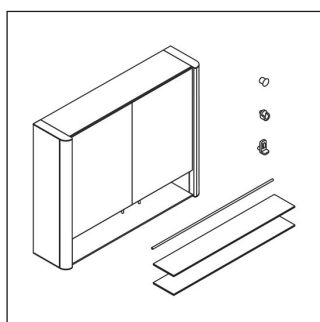
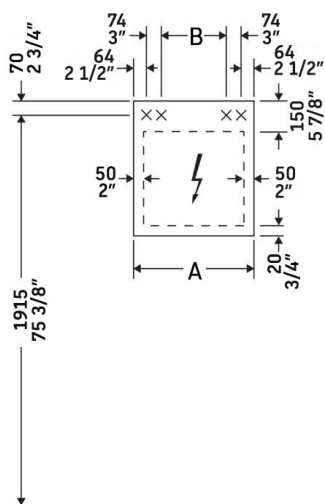

Instructions for use

The bathroom furniture range complies with the standards and guidelines applicable at the time of delivery and is designed for use in bathrooms. Though designed for the wet environment, direct contact with water should be avoided, for example, when showering. Power supply 110V - 230V must be provided on site. Distance between sensor and reflecting surfaces => 3" (75mm). We reserve the right to make technical improvements and design modifications to the products illustrated.

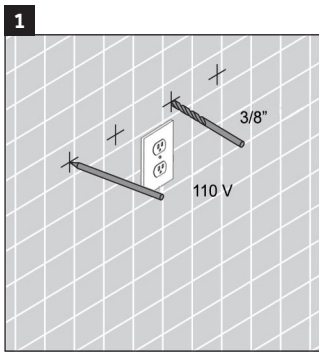

Reference the cabinet specification to establish the position of mounting bolts, mark the holes to be drilled for the anchors.

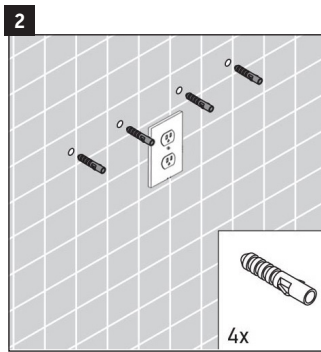

Drill the anchor holes that have been marked. Insert plastic anchors into the holes.

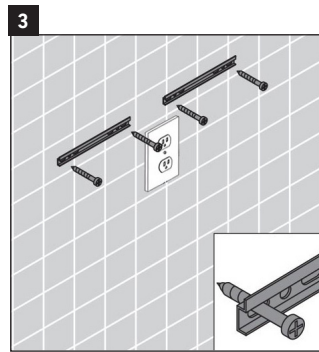

Screw the bracket(s) to the wall the specified locations. For wood stud walls, bolts should be screwed into wood backing.

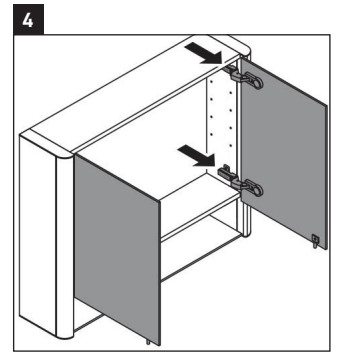

Remove the mirror fronts of the cabinet by unlatching each hinge.

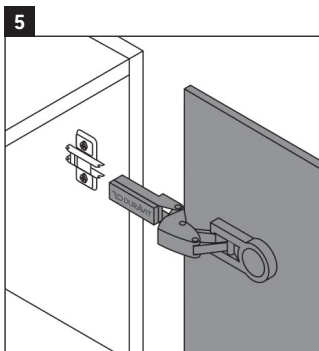

Unlatch the hinge.

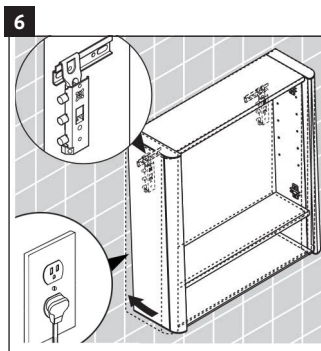

Plug the unit into outlet and lift the unit up and onto the mounting brackets.

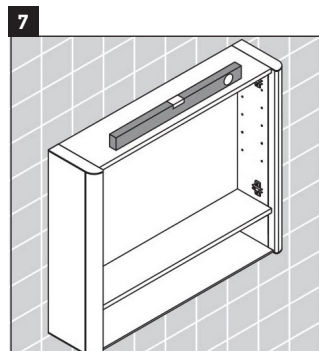

Check the cabinet is leveled and securely attached to the wall.

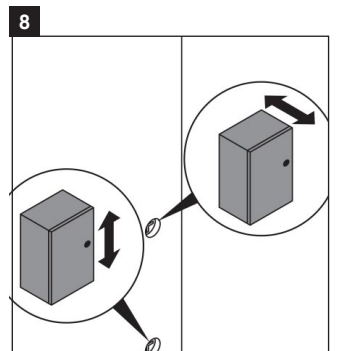

Check the screws which allow adjustments of the unit. The top screw will adjust front to back and the bottom screw will adjust up and down. Make adjustment to the level as needed.

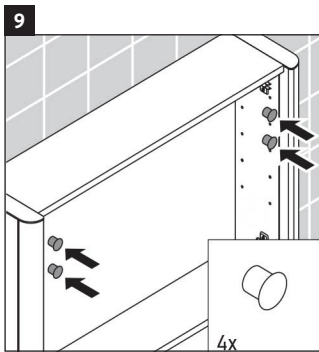

Add four plastic caps.

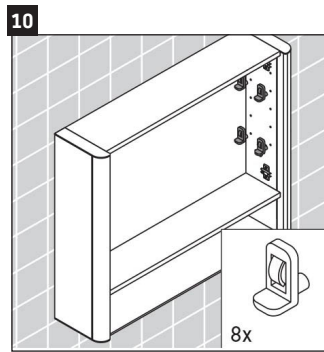

Add eight supplied shelf brackets.

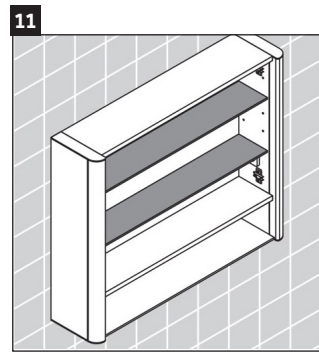

Add shelving to unit.

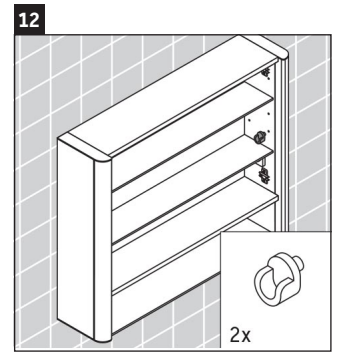

Add two brackets.

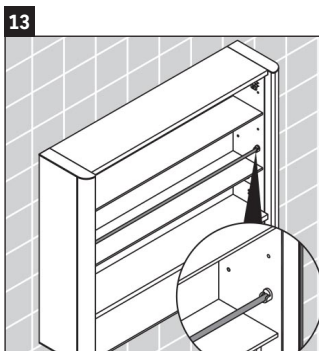

Add metal rod.

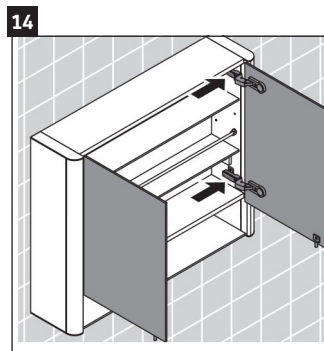

Re-attach the mirror fronts.

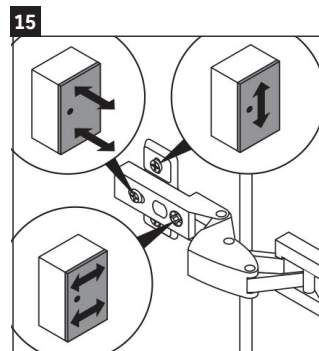

The top screw will adjust up and down. Back screw will adjust closer and further. From the mirror cabinet and front screw will adjust left and right.

Furniture complies with applicable requirements of the referenced standard(s):
Safety Household and Commercial Furnishings (UL 962, 3rd ed. Issued: 07/07/08, Revised: 08/05/13)
Portable Luminaires CSA C22.2 No. 12 - 1982 (R2004)

IMPORTANT SAFETY INSTRUCTIONS

When using an electrical furnishing, basic precautions should always be followed, including the following:

Read all instructions before using this furnishing.

DANGER To reduce the risk of electric shock:

1. Always power down all circuits before cleaning.

WARNING To reduce the risk of burns, fire, electric shock, or injury to persons:

1. Disconnect from power before putting on or taking off parts. A minimum of two people is required to remove and replace cabinet doors.
2. Close supervision is necessary when this furnishing is used by, or near children, invalids, or disabled persons.
3. Use this furnishing only for its intended use as described in these instructions. Do not use attachments not recommended by the manufacture.
4. Never operate this furnishing if it has a damaged cord or plug, if it is not working properly, if it has been dropped or damaged, or dropped into water. Return the furnishing to a service center for examination and repair.
5. Never drop or insert any object into any opening.
6. Do not use outdoors.
7. Do not operate where aerosol (spray) products are being used or where oxygen is being administered.
8. For loading always put heavier items at the bottom and not near the top in order to help prevent the possibility of the furnishing tipping over.
MAXIMUM SHELF LOAD IN POUNDS ALLOWED: 6.61 lbs
9. To disconnect, power down all circuits.
10. Risk of Injury to Persons - do not place video equipment such as televisions or computer monitors on furnishing.

GROUNDING INSTRUCTIONS

This product must be connected to a grounded metal, permanent wiring system, or an equipment - grounding conductor must be run with the circuit conductors and connected to the equipment grounding terminal or lead on the product.

ABOUT THE PRODUCT

Products requiring electricity are designed to be switched at the wall and hardwired to a circuit provided by the customer. Product should be installed according to electrical code by a qualified technician. Read important safety instructions carefully. Direct wetting should be avoided. This products is intended for household/residential use only. We reserve the right to make technical improvements and to enhance the appearance of the products shown.

SAVE THESE INSTRUCTIONS

Duravit NYC
105 Madison Avenue
New York, NY 10016
Toll Free 888-DURAVIT
Phone 212-686-0033
Fax 212-686-8033
info@us.duravit.com
www.duravit.nyc

Duravit USA, Inc.
2205 Northmont Pkwy., Ste. 200
Duluth, GA 30096
Toll Free 888-DURAVIT
Phone 770-931-3575
Fax 770-931-8454
info@us.duravit.com
www.duravit.us

