

# 380-3386

## Summit™ Dual Flush

Round Front, Vitreous China, Two-Piece Toilet



### Features

- Dual flush technology with 3" flush tower
- 1.1 Gpf / 1.6 Gpf (4.0 Lpf / 6.0 Lpf)
- SmartFasten™ 3-bolt tank-to-bowl connection
- Round front bowl
- PuraClean™ easy-to-clean glaze
- Pilot operated anti-siphon fill valve
- 12" rough-in
- Chrome push button actuator
- 2" glazed trapway
- The Mansfield® limited lifetime warranty
- Available in white and standard colors: biscuit and bone





Also available as a complete toilet kit.\*



Model 380-3386  
Toilet seat not included

### Components

Model #	Description	Codes/Standards
380-3386	Round front, two-piece dual flush toilet. Less toilet seat and supply. Specify color.	  
380	Round front toilet bowl only. Less toilet seat. Specify color.	
3386	Tank and cover only, with chrome push button actuator. Less supply. Specify color.	
*4380CTK	Round front, dual flush, complete toilet kit. Includes slow close toilet seat, tank and bowl, flange bolts, wax ring with polyethylene flange and instructions.	



MADE IN USA



# 380-3386

## Summit™ Dual Flush

Round Front, Vitreous China, Two-Piece Toilet



### Specifications

Model #	Description	Codes/Standards
380-3386	Round front, (1.1 / 1.6 gpf) two-piece dual flush toilet	  

Specification	Description	Specification	Description
Material	Vitreous china	Trap Diameter	2"
Water Pressure Range	20 to 80 PSI	Trap Seal	2-3/8"
Flush System	Dual flush with 3" flush tower	Rough-in	12"
Water Usage	1.1 / 1.6 gpf	Shipping Weight	Model 380 - 49 lbs.
Water Surface Area	8" X 9"		Model 3386 - 38 lbs.
MaP Rating	800 grams	Model 4380CTK - 91 lbs.	
		Warranty	Vitreous China - Limited Lifetime Tank Trim - Limited One Year

### Technical Information

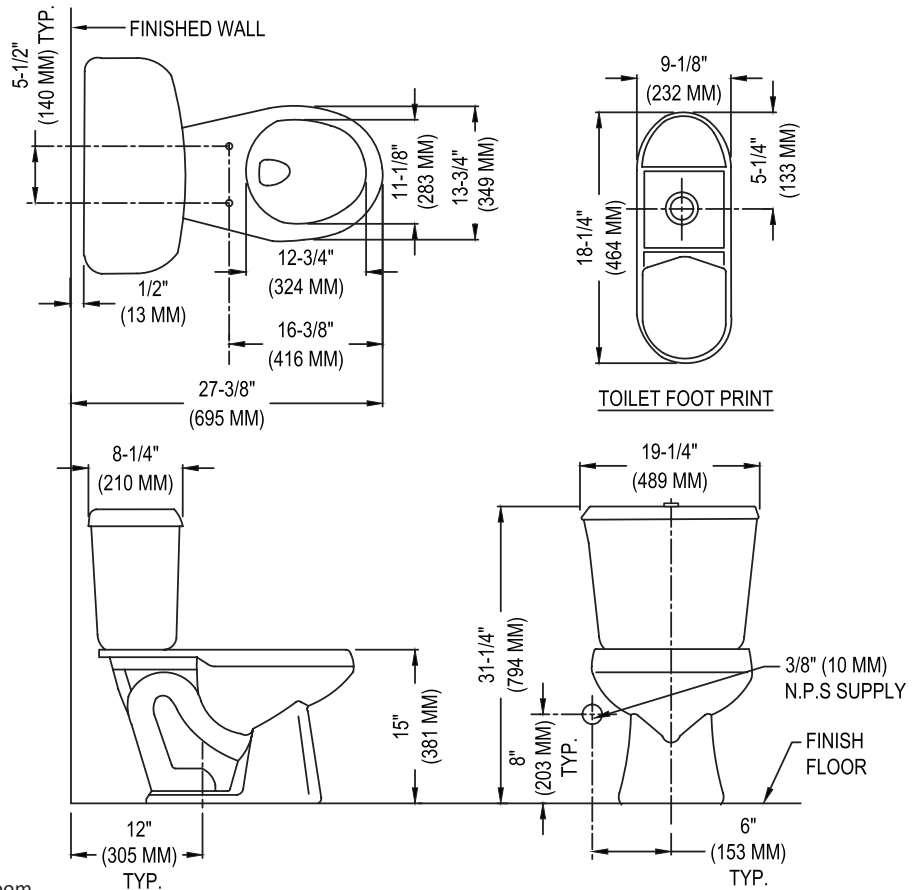

See our complete line of acrylic and vitreous china bathroom fixtures, plastic tank trim and plumbing products.

These dimensions are nominal and subject to change without notice.

Fixture performance and specifications meet or exceed ASME A112.19.2-2008/CSA B45.1-08 standards, and other state and local codes.



**MADE IN USA**