

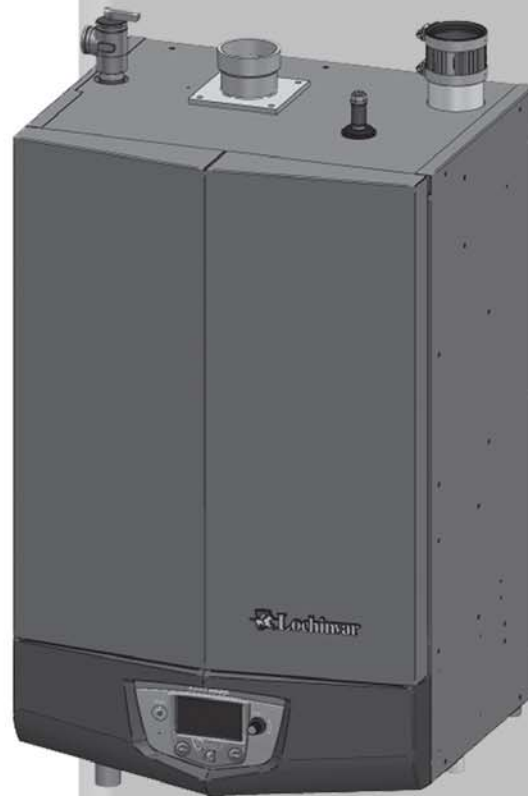

User's Information Manual
Models: 51 - 211



Lochinvar[®]
High Efficiency Water Heaters, Boilers and Pool Heaters

⚠ WARNING

If the information in this manual is not followed exactly, a fire or explosion may result causing property damage, personal injury or loss of life.

This appliance **MUST NOT** be installed in any location where gasoline or flammable vapors are likely to be present.

WHAT TO DO IF YOU SMELL GAS

- Do not try to light any appliance.
- Do not touch any electric switch; do not use any phone in your building.
- Immediately call your gas supplier from a near by phone. Follow the gas supplier's instructions.
- If you cannot reach your gas supplier, call the fire department.
- Installation and service must be performed by a qualified installer, service agency, or the gas supplier.

Save this manual for future reference.

Contents

HAZARD DEFINITIONS.....	2	3. OPERATING INSTRUCTIONS.....	9
PLEASE READ BEFORE PROCEEDING	3	4. SMART SYSTEM CONTROL MODULE	
1. PREVENT COMBUSTION AIR CONTAMINATION	4	SMART SYSTEM Control Module	10
2. MAINTENANCE SCHEDULE	5	Access Modes	10
Maintenance Procedures	6	Saving Parameters	10
Boiler Must Be Serviced and Maintained	6	General	10
Check Boiler Area.....	6	Temperature Settings	11
Check Pressure Temperature Gauge.....	6	Status Display Screens	12-14
Check Vent Piping	6	Notes.....	15
Check Air Piping	6	Revision Notes	Back Cover
Check Relief Valve	6		
Check Condensate Drain System	6-7		
Check Air Vents.....	8		
Test Low Water Cutoff (if installed)	8		
Reset Button (low water cutoff)	8		
Check Boiler Piping (gas and water)	8		
Operate Relief Valve	8		
Shut Boiler Down.....	8		

Hazard definitions

The following defined terms are used throughout this manual to bring attention to the presence of hazards of various risk levels or to important information concerning the life of the product.

DANGER

DANGER indicates an imminently hazardous situation which, if not avoided, will result in death or serious injury.

WARNING

WARNING indicates a potentially hazardous situation which, if not avoided, could result in death or serious injury.

CAUTION

CAUTION indicates a potentially hazardous situation which, if not avoided, may result in minor or moderate injury.

CAUTION

CAUTION used without the safety alert symbol indicates a potentially hazardous situation which, if not avoided, may result in property damage.

NOTICE

NOTICE indicates special instructions on installation, operation, or maintenance that are important but not related to personal injury or property damage.

Please read before proceeding

NOTICE

The Knight Wall Mount Installation and Operation Manual along with the Knight Wall Mount Service Manual are for use only by a qualified heating installer/service technician. Refer only to this User's Information Manual for your reference. Improper installation, adjustment, alteration, service or maintenance can cause property damage, personal injury (exposure to hazardous materials) or loss of life. Installation and service must be performed by a qualified installer, service agency or the gas supplier (who must read and follow the supplied instruction before installing, servicing, or removing this boiler. This boiler contains materials that have been identified as carcinogenic, or possibly carcinogenic, to humans).

NOTICE

When calling or writing about the boiler – Please have the boiler model and serial number from the boiler rating plate.

Consider piping and installation when determining boiler location.

Any claims for damage or shortage in shipment must be filed immediately against the transportation company by the consignee.

Factory warranty (shipped with unit) does not apply to units improperly installed or improperly operated.

⚠ WARNING

Failure to adhere to the guidelines on this page can result in severe personal injury, death, or substantial property damage.

Boiler service and maintenance –

- To avoid electric shock, disconnect electrical supply before performing maintenance.
- To avoid severe burns, allow boiler to cool before performing maintenance.

Boiler operation –

- Do not block flow of combustion or ventilation air to the boiler. This boiler is equipped with a control which will automatically shut down the boiler should air or vent be blocked. If vent or air blockage is easily accessible and removable, remove it. The boiler should attempt to restart. If blockage is not obvious or cannot be removed, have the boiler and system checked by a qualified service technician.
- Should overheating occur or gas supply fail to shut off, do not turn off or disconnect electrical supply to the circulator. Instead, shut off the gas supply at a location external to the appliance.
- Do not use this boiler if any part has been under water. The possible damage to a flooded appliance can be extensive and present numerous safety hazards. Any appliance that has been under water must be replaced.

Boiler water –

- Thoroughly flush the system (without boiler connected) to remove sediment. The high-efficiency heat exchanger can be damaged by build-up or corrosion due to sediment.
- Do not use petroleum-based cleaning or sealing compounds in the boiler system. Gaskets and seals in the system may be damaged. This can result in substantial property damage.
- Do not use “homemade cures” or “boiler patent medicines”. Serious damage to the boiler, personnel, and/or property may result.
- Continual fresh make-up water will reduce boiler life. Mineral buildup in the heat exchanger reduces heat transfer, overheats the stainless steel heat exchanger, and causes failure. Addition of oxygen carried in by makeup water can cause internal corrosion. Leaks in boiler or piping must be repaired at once to prevent makeup water.

Freeze protection fluids –

- NEVER use automotive antifreeze. Use only inhibited propylene glycol solutions, which are specifically formulated for hydronic systems. Ethylene glycol is toxic and can attack gaskets and seals used in hydronic systems.

1 Prevent combustion air contamination

⚠ WARNING

If the boiler combustion air inlet is located in any area likely to cause contamination, or if products which would contaminate the air cannot be removed, you must have the combustion air and vent re-piped and terminated to another location. Contaminated combustion air will damage the boiler, resulting in possible severe personal injury, death, or substantial property damage.

⚠ WARNING

If the boiler combustion air inlet is located in a laundry room or pool facility, for example, these areas will always contain hazardous contaminants.

Pool and laundry products and common household and hobby products often contain fluorine or chlorine compounds. When these chemicals pass through the boiler, they can form strong acids. The acid can eat through the boiler wall, causing serious damage and presenting a possible threat of flue gas spillage or boiler water leakage into the building.

Please read the information listed in Table 1A. If contaminating chemicals will be present near the location of the boiler combustion air inlet, have your installer pipe the boiler combustion air and vent to another location, per the Knight Wall Mount Installation and Operation Manual.

⚠ WARNING

To prevent the potential of severe personal injury or death, check for areas and products listed in Table 1A before installing the boiler or air inlet piping.

If contaminants are found, you **MUST**:

- Remove contaminants permanently.
- OR—
- Relocate air inlet and vent terminations to other areas.

Table 1A Corrosive Contaminants and Sources

Products to avoid:
Spray cans containing chloro/fluorocarbons
Permanent wave solutions
Chlorinated waxes/cleaners
Chlorine-based swimming pool chemicals
Calcium chloride used for thawing
Sodium chloride used for water softening
Refrigerant leaks
Paint or varnish removers
Hydrochloric acid/muriatic acid
Cements and glues
Antistatic fabric softeners used in clothes dryers
Chlorine-type bleaches, detergents, and cleaning solvents found in household laundry rooms
Adhesives used to fasten building products and other similar products
Areas likely to have contaminants
Dry cleaning/laundry areas and establishments
Swimming pools
Metal fabrication plants
Beauty shops
Refrigeration repair shops
Photo processing plants
Auto body shops
Plastic manufacturing plants
Furniture refinishing areas and establishments
New building construction
Remodeling areas
Garages with workshops

2 Maintenance schedule

Service technician (see the Knight Wall Mount Service Manual)		Owner maintenance (see pages 6 - 8 for detailed instructions)	
ANNUAL START-UP	General:		
	<ul style="list-style-type: none"> • Reported problems • Inspect interior; clean and vacuum if necessary • Clean condensate trap and fill with fresh water • Check for leaks (water, gas, flue, condensate) • Verify flue and air lines in good condition and sealed tight • Check system water pressure/system piping/expansion tank • Check control settings • Ignition and flame sense electrodes (sand off any deposits; clean and reposition) • Wiring and connections • Perform start-up checkout and performance verification per Section 10 in the Knight Wall Mount Installation and Operation Manual. • Flame inspection (stable, uniform) • Flame signal (at least 4 mA) • Clean the heat exchanger if flue temperature is more than 54°F above return water temperature. 	Daily	<ul style="list-style-type: none"> • Check boiler area • Check pressure/temperature gauge
	<p>If combustion or performance indicate need:</p> <ul style="list-style-type: none"> • Clean heat exchanger • Remove and clean burner using compressed air only • Clean the blower wheel 	Monthly	<ul style="list-style-type: none"> • Check vent piping • Check air piping • Check air and vent termination screens • Check relief valve • Check condensate drain system • Check air vents
		Periodically	<ul style="list-style-type: none"> • Test low water cutoff (if used) • Reset button (low water cutoff)
		Every 6 months	<ul style="list-style-type: none"> • Check boiler piping (gas and water) for leaks • Operate relief valve
	End of season months	<ul style="list-style-type: none"> • Shut boiler down (unless boiler used for domestic hot water) 	

⚠ WARNING

Follow the maintenance procedures given throughout this manual. Failure to perform the service and maintenance or follow the directions in this manual could result in damage to the boiler or system, resulting in severe personal injury, death, or substantial property damage.

2 Maintenance schedule

Maintenance procedures

Boiler must be serviced and maintained

⚠ WARNING The boiler must be inspected and started annually at the beginning of the heating season by a qualified service technician. In addition, the maintenance and care of the boiler designated on page 5 of this manual and explained on pages 6 through 8 must be performed to assure maximum boiler efficiency and reliability. Failure to service and maintain the boiler and system could result in equipment failure, causing possible severe personal injury, death, or substantial property damage.

NOTICE The following information provides detailed instructions for completing the maintenance items listed in the maintenance schedule on page 5. In addition to this maintenance, the boiler must be serviced and started up at the beginning of each heating season by a qualified service technician.

Check boiler area

⚠ WARNING To prevent potential of severe personal injury, death, or substantial property damage, eliminate all materials discussed below from the boiler vicinity and the vicinity of the boiler combustion air inlet. If contaminants are found:

Remove products immediately from the area. If they have been there for an extended period, call a qualified service technician to inspect the boiler for possible damage from acid corrosion.

If products cannot be removed, immediately call a qualified service technician to re-pipe vent and air piping and locate vent termination/air intake away from contaminated areas.

1. Combustible/flammable materials -- Do not store combustible materials, gasoline or any other flammable vapors or liquids near the boiler. Remove immediately if found.
2. Air contaminants -- Products containing chlorine or fluorine, if allowed to contaminate the boiler intake air, will cause acidic condensate in the boiler. This will cause significant damage to the boiler if allowed to continue.

Read the list of potential materials listed in Table 1A on page 4 of this manual. If any of these products are in the room from which the boiler takes its combustion air, they must be removed immediately or the boiler combustion air (and vent termination) must be relocated to another area.

Check pressure/temperature gauge

1. Make sure the pressure reading on the boiler pressure/temperature gauge does not exceed 24 psi. Higher pressure may indicate a problem with the expansion tank.
2. Contact a qualified service technician if problem persists.

Check vent piping

1. Visually inspect the flue gas vent piping for any signs of blockage, leakage, or deterioration of the piping. Notify your qualified service technician at once if you find any problems.

⚠ WARNING Failure to inspect the vent system as noted above and have it repaired by a qualified service technician can result in vent system failure, causing severe personal injury or death.

Check air piping

1. Visually inspect the air inlet termination to be sure it is unobstructed. Inspect the entire length of air piping to ensure piping is intact and all joints are properly sealed.
2. Call your qualified service technician if you notice any problems.

Check relief valve

1. Inspect the boiler relief valve and the relief valve discharge pipe for signs of weeping or leakage.
2. If the relief valve often weeps, the expansion tank may not be working properly. Immediately contact your qualified service technician to inspect the boiler and system.

Check condensate drain system

1. Inspect the condensate drain line, condensate PVC fittings and condensate trap.

Fill condensate trap with water

1. Remove the bezel on the front of the unit.
2. Remove the PVC cap retaining screw from the PVC cap (FIG. 2-1).
3. Remove the 2" PVC cap with the switch located at the top of the trap (FIG. 2-1).

2 Maintenance schedule *(continued)*

4. Fill with fresh water until the water begins to pour out of the drain.
5. Replace the cap. Press the cap onto the trap until the cap makes contact with the drain.
6. Replace the retaining screw.

WARNING

The condensate trap (FIG. 2-1) must be filled with water during all times of boiler operation to avoid flue gas emission from the condensate drain line. Failure to fill the trap could result in severe personal injury or death.

NOTICE

Use materials approved by the authority having jurisdiction. In the absence of other authority, PVC and CPVC pipe must comply with ASTM D1785 or D2845. Cement and primer must comply with ASME D2564 or F493. For Canada use CSA or ULC certified PVC or CPVC pipe, fittings, and cement.

NOTICE

To allow for proper drainage on large horizontal runs, a second line vent may be required and tubing size may need to increase to 1 inch.

The condensate line must remain unobstructed, allowing free flow of condensate. If condensate is allowed to freeze in the line or if the line is obstructed in any other manner, condensate can exit from the boiler tee, resulting in potential water damage to property. Call your qualified service technician to inspect the boiler and system.

Figure 2-1 Condensate Trap

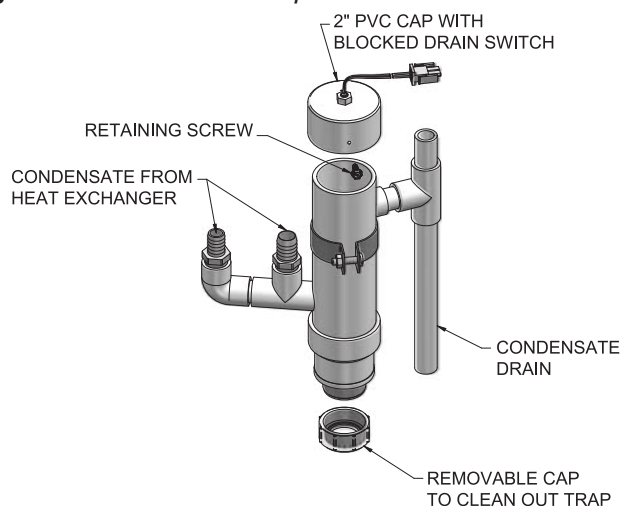

7. A condensate removal pump is required if the boiler is below the drain. When installing a condensate pump, select one approved for use with condensing boilers and furnaces. The pump should have an overflow switch to prevent property damage from condensate spillage. Call your qualified service technician to inspect the boiler and system.

Condensate disposal

1. This boiler is a high efficiency appliance that produces condensate.
2. The bottom of the boiler has a 1/2 inch pipe for connection of a 1/2 inch PVC pipe (FIG. 2-2).
3. Slope condensate tubing down and away from the boiler into a drain or condensate neutralizing filter. Condensate from the Knight wall mount boiler will be slightly acidic (typically with a pH from 3 to 5). Install a neutralizing filter if required by local codes. Call your qualified service technician to inspect the boiler and system.

A Neutralizer Kit is available from the factory (Kit #3087). Call your qualified service technician to install.

4. Do not expose condensate line to freezing temperatures.
5. Use only plastic tubing or piping as a condensate drain line (FIG. 2-2).
6. Leave the top of the tee assembly installed in the unit open, this is needed as a vacuum break. The blocked drain switch will shut the boiler down before any condensate can flow out of the tee.

Figure 2-2 Condensate Disposal

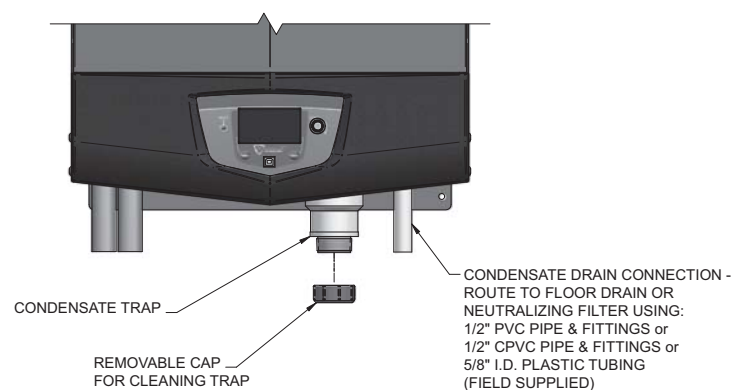

2 Maintenance schedule

Check air vents

1. Reference FIG. 2-3 below.
2. Visually inspect vent to make sure that no leaks are present.
3. If there is leaking, tighten the pin valve.
4. If the leaking continues, replace the air vent.

Figure 2-3 Air Vent

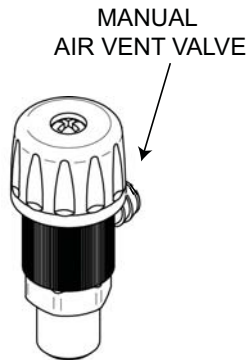

Test low water cutoff (if installed)

1. If the system is equipped with a low water cutoff, test the low water cutoff periodically during the heating season, following the low water cutoff manufacturer's instructions.

Reset button (low water cutoff)

1. Testing the low water cutoff shuts the unit off. Press the RESET button on the low water cutoff to turn the unit back on.

Check boiler piping (gas and water)

1. Remove the boiler front access door and perform a gas leak inspection per steps 1 through 7 of the Operating Instructions on page 9. If gas odor or leak is detected, immediately shut down the boiler following the procedures on page 9. Call a qualified service technician.
2. Visually inspect for leaks around water piping. Also inspect the circulators, relief valve, and fittings. Immediately call a qualified service technician to repair any leaks.

WARNING

Have leaks fixed at once by a qualified service technician. Failure to comply could result in severe personal injury, death, or substantial property damage.

3. Replace the front access door.

Operate relief valve

1. Before proceeding, verify that the relief valve outlet has been piped to a safe place of discharge, avoiding any possibility of scalding from hot water.

WARNING

To avoid water damage or scalding due to valve operation, a metal discharge line must be connected to the relief valve outlet and run to a safe place of disposal. This discharge line must be installed by a qualified heating installer or service technician in accordance with the instructions in the Knight Wall Mount Installation and Operation Manual. The discharge line must be terminated so as to eliminate possibility of severe burns or property damage should the valve discharge.

2. Read the boiler pressure/temperature gauge to make sure the system is pressurized. Lift the relief valve top lever slightly, allowing water to relieve through the valve and discharge piping.
3. If water flows freely, release the lever and allow the valve to seat. Watch the end of the relief valve discharge pipe to ensure that the valve does not weep after the line has had time to drain. If the valve weeps, lift the seat again to attempt to clean the valve seat. If the valve continues to weep afterwards, contact your qualified service technician to inspect the valve and system.
4. If water does not flow from the valve when you lift the lever completely, the valve or discharge line may be blocked. Immediately shut down the boiler, following the operating instructions on page 9 of this manual. Call your qualified service technician to inspect the boiler and system.

Shut boiler down (unless boiler is used for Domestic Water)

1. Follow "To Turn Off Gas to Appliance" on page 9 of this manual.
2. Do not drain the system unless exposure to freezing temperatures will occur.
3. Do not drain the system if it is filled with an antifreeze solution.
4. DO NOT shut down boilers used for domestic water heating, they must operate year-round.

3 Operating instructions

FOR YOUR SAFETY READ BEFORE OPERATING

WARNING: If you do not follow these instructions exactly, a fire or explosion may result causing property damage, personal injury, or loss of life.

- | | |
|--|--|
| <p>A. This appliance does not have a pilot. It is equipped with an ignition device which automatically lights the burner. Do <u>not</u> try to light the burner by hand.</p> <p>B. BEFORE OPERATING smell all around the appliance area for gas. Be sure to smell next to the floor because some gas is heavier than air and will settle on the floor.</p> <p>WHAT TO DO IF YOU SMELL GAS</p> <p>Do not try to light any appliance.</p> <p>Do not touch any electric switch; do not use any phone in your building.</p> | <p>Immediately call your gas supplier from a neighbor's phone. Follow the gas supplier's instructions.</p> <p>If you cannot reach your gas supplier, call the fire department.</p> <p>C. Use only your hand to move the gas control switch. Never use tools. If the switch will not move by hand, don't try to repair it, call a qualified service technician. Force or attempted repair may result in a fire or explosion.</p> <p>D. Do not use this appliance if any part has been under water. Immediately call a qualified service technician to inspect the appliance and to replace any part of the control system and any gas control which has been under water.</p> |
|--|--|

OPERATING INSTRUCTIONS

- | | |
|--|---|
| <ol style="list-style-type: none"> 1. STOP! Read the safety information above on this label. 2. Set the thermostat to lowest setting. 3. Turn off all electric power to the appliance. 4. This appliance is equipped with an ignition device which automatically lights the burner. Do not try to light the burner by hand. 5. Remove front door. 6. Move switch to the "OFF" position. 7. Wait five (5) minutes to clear out any gas. If you then smell gas, STOP! Follow "B" in the safety information above this label. If you don't smell gas, go to next step. | <ol style="list-style-type: none"> 8. Move the switch to the "ON" position. 9. Install front door. 10. Turn on all electric power to appliance. 11. Set thermostat to desired setting. 12. If the appliance will not operate, follow the instructions "To Turn Off Gas To Appliance" and call your service technician or gas supplier. |
|--|---|

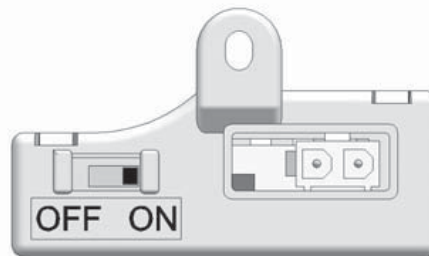

TO TURN OFF GAS TO APPLIANCE

- | | |
|---|---|
| <ol style="list-style-type: none"> 1. Set the thermostat to lowest setting. 2. Turn off all electric power to the appliance if service is to be performed. 3. Remove front door. | <ol style="list-style-type: none"> 4. Move the switch to the "OFF" position. 5. Install front door. |
|---|---|

4 SMART SYSTEM control module

SMART SYSTEM™ Knight wall mount control module

Use the control panel (FIG. 4-1) to set temperatures, operating conditions, and monitor boiler operation.

Figure 4-1 Control Panel

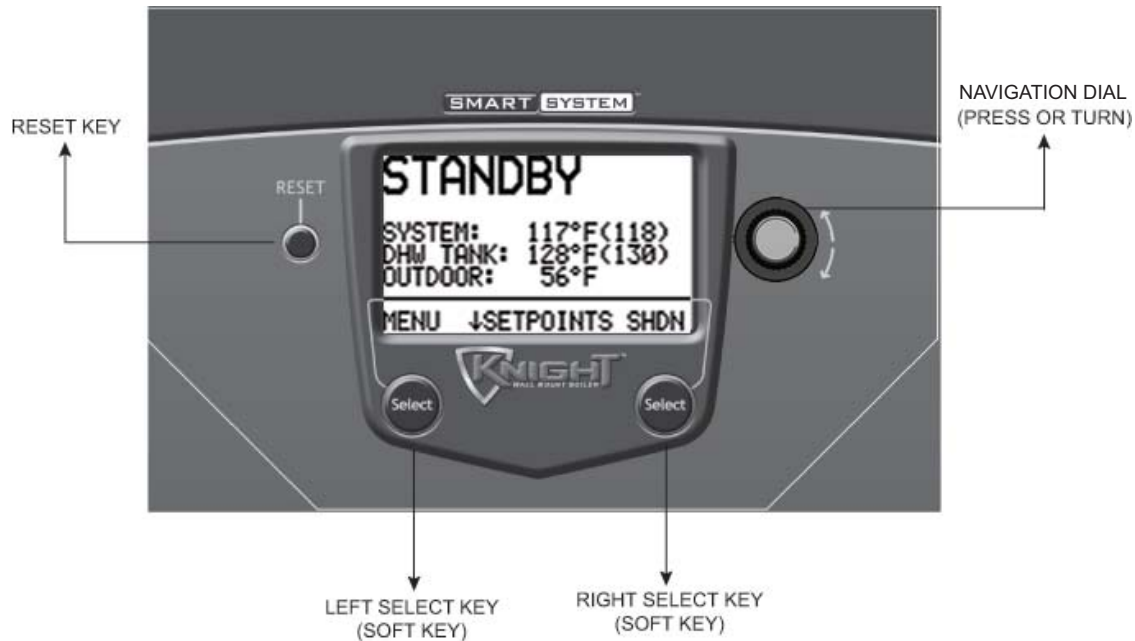

The information on the bottom of the display shows the functions of the two SELECT keys (on either corner), and the NAVIGATION dial (in the center):
 MENU = Left SELECT Key
 SETPOINTS = NAVIGATION Dial - Pressing Down
 SHDN = Right SELECT Key

Access modes

NOTICE Please note that the brackets ([]) denote screen status.

User

The user can adjust space heating and tank target temperatures by pressing the NAVIGATION dial when “↓SETPOINTS” is flashing at the bottom of the display. The user can adjust the date and time, temperature units, and night setback override (if active) by pressing the LEFT SELECT [MENU] key for 5 seconds. When the user password “0000” appears, then press the RIGHT SELECT [SAVE] key (do not change the password).

Installer

Most parameters are available only to the installer, accessible only by entering the installer password, see the Knight Boiler Service Manual.

Saving parameters

Press the RIGHT SELECT [SAVE] key one time to return to the parameter listing. Press the RIGHT SELECT [HOME] key again to store the new settings and return to the Status Screen.

Adjusting parameters

CAUTION Before changing parameters, note the settings so that the unit can be returned to its original operating parameters.

The control uses an internal clock for the night setback feature and for logging of events. For these features to work properly, the clock must be set when the boiler is first installed or any time the boiler has been powered off for more than four (4) hours. This parameter must be accessed to set the clock.

NOTICE The internal clock does not adjust for Daylight Savings Time and therefore, will require a manual adjustment.

To set the clock, access the clock menu as described in the *User* section. Rotate the NAVIGATION dial (if needed) until the arrow (>) is pointing to “TIME & DATE”. Press the NAVIGATION dial once. If the date and time are incorrect, press the NAVIGATION dial again. The hours value will begin flashing. Rotate the NAVIGATION dial until the hour and AM/PM values are correct. Press the NAVIGATION dial again. The minutes value will begin flashing. Rotate the NAVIGATION dial to adjust the minutes. Repeat this procedure to adjust the month, date and year. Save the new settings as described in the *Saving Parameters* section (this page).

4 SMART SYSTEM control module *(continued)*

Night Setback Override

Any Night Setback On trigger currently active or scheduled within the next seven (7) days can be skipped. To skip a trigger, rotate the NAVIGATION dial until the arrow (>) is next to the trigger you wish to skip. Press the NAVIGATION dial once. "SK" will appear next to that trigger to indicate that it will be skipped. You can restore an upcoming trigger by selecting that trigger, and pressing the NAVIGATION dial again. The "SK" next to that trigger will disappear.

To save any changes and return to the Home Screen, press the RIGHT SELECT [HOME] key. To return to the Status Screen without saving the changes, press the LEFT SELECT [EXIT] key.

Temperature Units

The control can be configured to display temperature in either °F or °C. This parameter can be changed by the user or the installer by accessing the *Temperature Units parameter*. The default is °F. To change the temperature units, access the clock menu as described in the *User* section (this page). Rotate the NAVIGATION dial until the arrow (>) is pointing to "TEMPERATURE UNIT °F". Press the NAVIGATION dial once. The temperature unit will begin to flash. Rotate the NAVIGATION dial until the desired temperature unit is shown. Save the new setting as described in the *Saving Parameters* section (page 10).

Space heating (SH1, SH2, SH3) and tank set points

CAUTION

Mixing valves are required for the protection of any low temperature loops.

There are three (3) individual user set points for better zone control. These are listed as SH1 Set Point through SH3 Set Point. If multiple set points are calling for heat the highest set point has priority. The range is *SH Minimum Set point* to *SH Maximum Set point* (32°F (0°C) - 190°F (88°C)). The default is 125°F (52°C).

By installing a tank sensor, the SMART SYSTEM control can perform the tank thermostat function. The SMART SYSTEM control automatically detects the presence of this sensor, and generates a DHW call for heat when the tank temperature drops 6°F (-14°C) below the tank set point differential (*Tank Set point Differential parameter*), and finishes the call for heat when the tank temperature reaches tank set point + offset. This parameter can be changed by the installer by accessing the *DHW Tank Set point parameter*. The temperature range of this parameter is 68°F (20°C) to 190°F (88°C). The default value is 125°F (52°C).

Press the NAVIGATION dial once. A menu will appear showing the SH1, SH2, SH3, and DHW Set Points. Rotate the NAVIGATION dial until the arrow (>) is pointing to the setting you wish to change. Press the NAVIGATION dial again. The value of the selected setting will begin to flash. Rotate the NAVIGATION dial to adjust the value. Save the new setting as described in the *Saving Parameters* section (page 10).

4 SMART SYSTEM control module

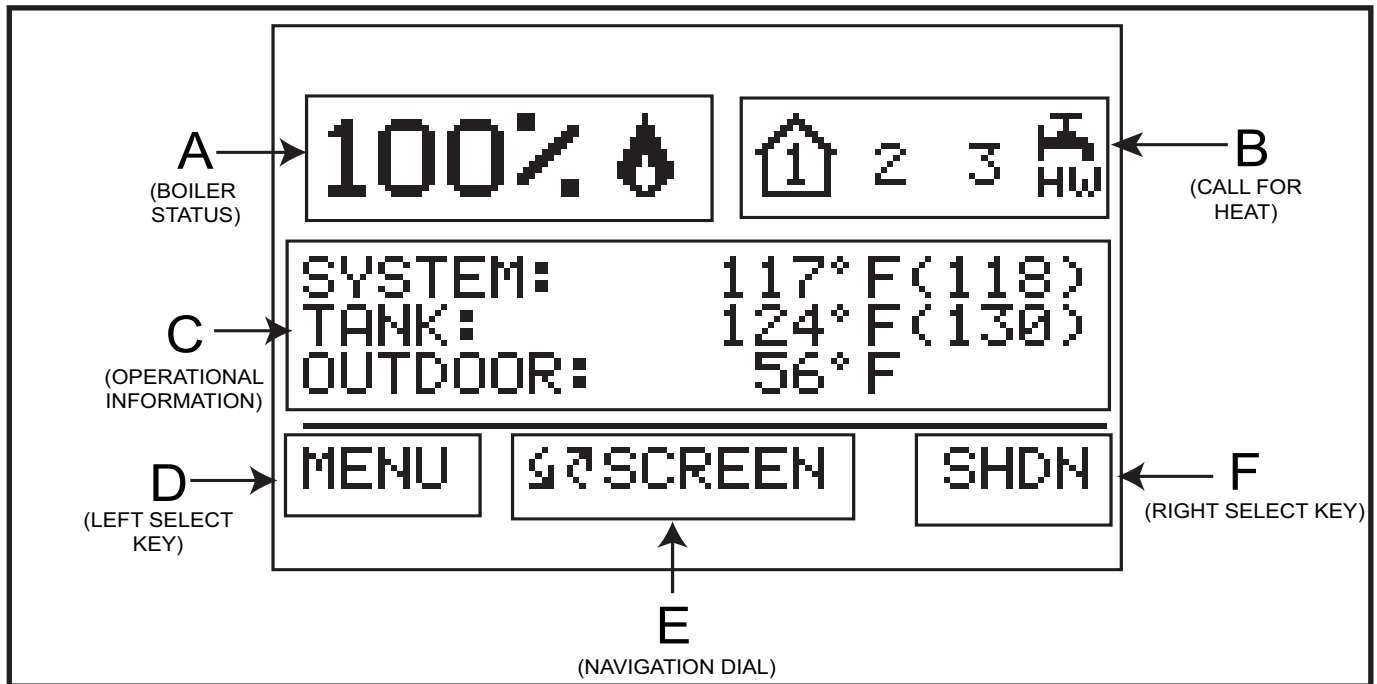
Figure 4-2 Status Display Screen

Status Display Screens		
Section	Display	Description
A (Boiler Status Bar)	STANDBY	The unit has not received a call for heat from a remote thermostat nor has it received a call for heat from a DHW thermostat.
	START	The unit has begun a burn cycle and is checking all safety circuits.
	PREPURGE	The unit has initiated a prepurge period on a call for heat.
	IGNITION	The unit has begun a spark period to ignite the main burner.
	% 🔥	The unit has fired and is running at the displayed percentage.
	POSTPURGE	The call for heat has been satisfied and the unit runs the fan for an additional postpurge period to clear the combustion chamber and vent system of residual flue products.
	SHUTDOWN	The unit has been placed in the OFF position.
	SETPOINT MET	The controlled temperature has exceeded its set point and its offset.
	BLOCKED	The unit has detected a condition that has temporarily interrupted the current call for heat.
B (Call for Heat Indicators)	1	Room Thermostat 1 has a call for heat.
	2	Room Thermostat 2 has a call for heat.
	3	Room Thermostat 3 has a call for heat.
	🏠 HW	The tank thermostat or sensor has a call for heat.
	🏠 1 2 3	Indicates which room thermostat demand shows priority.
	🏠 V	The unit is being controlled by a 0 - 10V BMS signal.
	🏠 C	The member unit is supplying heat while in Cascade Mode.

4 SMART SYSTEM control module *(continued)*

Status Display Screens <i>(cont'd)</i>		
Section	Display	Description
C (Operational Information)	SYSTEM:	The temperature read by the system supply sensor (if connected).
	TANK:	The temperature read by the tank sensor (if connected).
	OUTDOOR:	The temperature read by the outdoor sensor (if connected).
	INLET TEMP:	The temperature read at the inlet to the heat exchanger.
	OUTLET TEMP:	The temperature read at the outlet of the heat exchanger.
	DELTA T:	The temperature difference between the inlet and the outlet of the heat exchanger.
	FLUE TEMP:	The temperature read by the flue sensor.
	FLAME CURRENT:	The current measured by the flame sense circuit.
	FAN SPEED:	The speed of the combustion blower.
	BOILER PUMP:	The status of the boiler pump output.
	SYSTEM PUMP:	The status of the system pump output.
	DHW PUMP:	The status of the DHW pump output.
	BMS VOLTAGE:	The voltage received from a BMS system.
	BLR PUMP OUTPUT:	The speed signal sent to a variable speed boiler pump in percent.
	SYS PUMP INPUT:	The speed signal received from a variable speed system pump control.
	RATE OUTPUT:	A 0 - 10V signal indicating the firing rate of the boiler.
	SH RUN HOURS:	The total hours of operation in the Space Heating Mode.
	SH CYCLES:	The total burner cycles in the Space Heating Mode.
	DHW RUN HOURS:	The total hours of operation in the DHW Mode.
	DHW CYCLES:	The total burner cycles in the DHW Mode.
LAST 10 FAULTS NO:*	The last 10 lockouts.	
NIGHT SETBACK	Shows the next Night Setback trigger (if active).	

4 SMART SYSTEM control module

Status Display Screens (cont'd)		
Section	Display	Description
D (LEFT SELECT key function)	MENU	Press and hold the LEFT SELECT key for 5 seconds to enter the Menu Screen.
	EXIT	Press the LEFT SELECT key to exit the current screen or setting.
	YES	Press the LEFT SELECT key to confirm that the boiler needs to shutdown.
	LIMITS	Press the LEFT SELECT key to enter the screen that allows you to adjust the limit settings.
	HOME	Press the LEFT SELECT key to return to the Status Screen and upload parameter changes.
	SKIP	Press the LEFT SELECT key when in the Night Setback Screen to access the Night Setback Skip Screen.
E (NAVIGATION Dial Function)	↻ SCREEN	Turning the NAVIGATION dial will select the next or previous Status Screen.
	↓ NEXT	Pressing the NAVIGATION dial will show the next fault, NSB (Night Setback) trigger, or ramp delay setting.
	↓ SELECT	Pressing the NAVIGATION dial will select the setting indicated by the cursor.
	↓ SETPOINTS	Pressing the NAVIGATION dial will display the Set Points Screen.
	↻ SCROLL	Turning the NAVIGATION dial will move the cursor up or down.
	↻ ADJUST	Turning the NAVIGATION dial will increase or decrease the current setting.
F (RIGHT SELECT key function)	SHDN	Press the RIGHT SELECT key to turn the boiler OFF.
	ON	Press the RIGHT SELECT key to turn the boiler ON.
	NO	Press the RIGHT SELECT key to cancel the shutdown operation.
	SAVE	Press the RIGHT SELECT key to save the current change.
	HOME	Press the RIGHT SELECT key to return to the Status Screen and upload parameter changes.

Notes



Revision Notes: *Revision A (ECO C05747) initial release. Reflects the new model numbers for the Knight Wall Mount upgrade.*

Revision B (ECO C07072) reflects the change in design of the manual air vent and the update of FIG. 2-3 on page 8.

Revision C (ECO #C09161) reflects updates made to the SMART SYSTEM control (ECR #R04523).

Revision D (ECO #C10143) reflects updates made to the ignition timing information.