

4135-3121

Alto®

Elongated Front, Vitreous China, Two-Piece Toilet



Features

- 3 bolt tank-to-bowl connection
- 1.28 gpf / 4.86 lpf low water consumption
- Uses 20% less water than conventional toilets
- Elongated front bowl
- 3" hybrid flush valve
- Pilot operated fill valve
- 12" rough-in
- Color-match trip lever
- 2" glazed trapway
- The Mansfield® limited lifetime warranty
- Available in white and standard colors: biscuit, bone





Model 4135-3121
Toilet seat not included



*Also available as a complete toilet package.

Components

Model #	Description	Codes/Standards
4135-3121	Elongated front, two-piece toilet. Less toilet seat and supply. Specify color.	  
4135	Elongated front toilet bowl only. Less toilet seat. Specify color.	
3121	Tank and cover only, with left hand, front-mount, color-match trip lever. Less supply. Specify color.	
3121RH	Same as model 3121, with right hand, color-match trip lever. Less supply. Specify color.	
3120	Same as 3121 with chrome trip lever.	
3120RH	Same as 3120 with right hand trip lever.	
3122	Same as model 3121, with tank liner.	
*4135CTK	Elongated front, complete toilet kit. Includes toilet seat, tank and bowl, flange bolts, wax ring with polyethylene flange and instructions.	
*4135LTCTK	Same as 4135CTK, with tank liner.	
SB400	Elongated, SmartClose™, toilet seat. Specify color.	



MADE IN USA



4135-3121

Alto®

Elongated Front, Vitreous China, Two-Piece Toilet



Specifications

Model #	Description	Codes/Standards
4135-3121	Elongated front (1.28 gpf/4.86 lpf) two-piece toilet	  

Specification	Description	Specification	Description
Material	Vitreous china	Trap Diameter	2"
Water Pressure Range	20 to 80 PSI	Trap Seal	2-5/8"
Flush System	3" hybrid valve	Rough-in	12"
Water Usage	1.28 gpf / 4.86 lpf	Shipping Weight	Model 4135 - 52 lbs. Model 3121 - 33 lbs. Models 4135CTK and 4135LTCTK - 88 lbs.
Water Surface Area	8-1/16" X 9-5/16"	Warranty	Vitreous China - Limited Lifetime Tank Trim - Limited One Year
MaP Rating	600 grams		

Technical Information

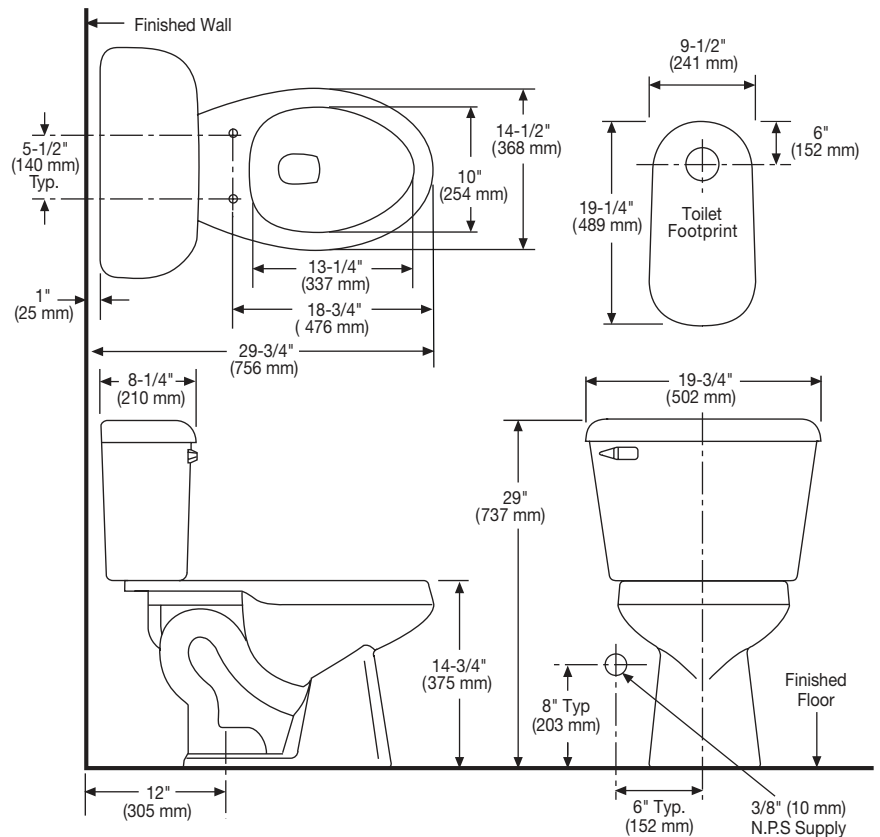

See our complete line of acrylic and vitreous china bathroom fixtures, plastic tank trim and plumbing products.

These dimensions are nominal and subject to change without notice.

Fixture performance and specifications meet or exceed ASME A112.19.2-2008/CSA B45.1-08 standards, and other state and local codes.



MADE IN USA