

Models 9053/9153/9253 Camden™

Ariance® Rectangular Air Massage Bath



Features

- 59-1/2" x 32" x 21-1/2" Rectangular air massage bath
- Three advanced therapy air bath systems
- Multifunctional digital controller
- Chromatherapy system — Seven healing light settings with a full spectrum sequencing mode
- PerfectBack™ — Multiple soothing recessed back jets with heated neck/back rest
- Heated SilentAir™ system
- QuickDrain™ channel system and automatic purge system
- Color-Match trim for air jets — Optional finishes available
- Cable drain with matching trim (optional)
- Decorative handles
- One pillow
- Mansfield® Limited Ten Year Warranty
- Available in standard colors (white, almond, biscuit and bone) and premium colors (British khaki, sterling silver, black and ice gray)



Model 9253

Options

Cable Drain

Model #	Description
SW1319	Standard Colors
SW1320	Polished Chrome
SW1321	Everbrass (PVD)
SW1322	Brushed Nickel
SW1323	Oil Rubbed Bronze

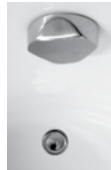

Metal Trim

Model #	Description
AR1335	Chrome
AR1336	Everbrass (PVD)
AR1337	Brushed Nickel
AR1338	Oil Rubbed Bronze



SWP151	Factory installed nailing flange		SWA200	Custom Pillow	
SWAP00	Nailing Flange Kit		SW1325	5-foot Removable Apron	
AR1200	Blower Relocation Kit				



MADE IN USA



Models 9053/9153/9253

Camden™

Ariance® Rectangular Air Massage Bath



Specifications

Model #	Description	Codes/Standards
9053	59-1/2" x 32" x 21-1/2" Rectangular HealthTouch™ Air Massage Bath	  
9153	59-1/2" x 32" x 21-1/2" Rectangular GentleTouch™ Air Massage Bath	
9253	59-1/2" x 32" x 21-1/2" Rectangular Dual Therapy™ Air Massage Bath	

Specification	Description	Specification	Description
Material	Acrylic, fiberglass reinforced	Number of Jets	HealthTouch - 51 perimeter, side/back air jets GentleTouch - 42 body/foot micro air jets (7 injectors with 12 side/back jets) DualTherapy - 51 perimeter, side/back air jets and 42 body/foot micro air jets (7 injectors with 12 side/back jets)
Construction	Self-contained, pre-plumbed air massage bath, mounted on a pre-leveled base		
Electrical Requirements	Health and GentleTouch – One 120v, 20 Amp, GFCI dedicated circuit; DualTherapy – Two 120v, 20 Amp, GFCI dedicated circuits	Blower	HealthTouch & GentleTouch one variable speed, 120v, 60 Hz, 9.5 Amp, pre-mounted DualTherapy two variable speed, 120v, 60 Hz, 9.5 Amp, pre-mounted
Water Capacity	40 gal. (min.) / 60 gal. (max.)	Floor Loading Weight	47 lbs. / sq. ft. (229 kg/m ²)
On/Off Control	Health and GentleTouch – 5-button electronic control pad DualTherapy – 10-button electronic control pad	Shipping Weight	130 lbs. - HealthTouch/GentleTouch 145 lbs. - DualTherapy
		Warranty	Limited Ten Year

Technical Information

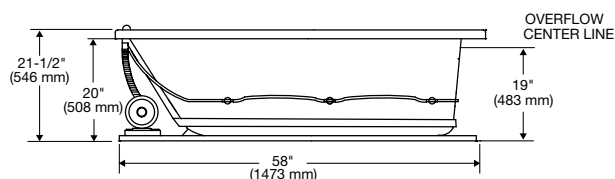
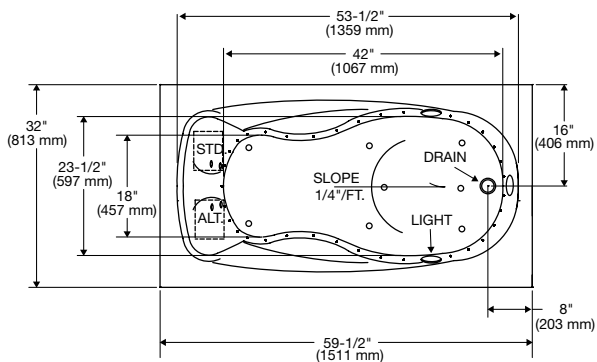

Blower locations are shown for clarity.
STD - standard blower location
ALT - alternative blower location.
Note: Install this product according to the installation guide.

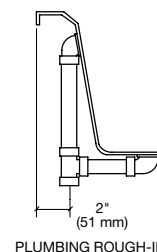
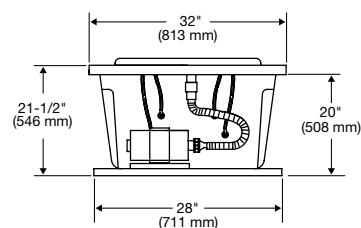

These dimensions are nominal and subject to change without notice.

When tested for compliance to the requirements of ASME A112.19.7M for "Whirlpool Bath Appliances" and ANSI Z124.1.2M "American National Standard for Plastic Bathtub and Shower Units", the tested units are found to comply and are acceptable for listing under IAPMO R & T.

Certified for permanent electrical connection only.



MADE IN USA