

**Models 6126A/6627**  
**PRO-FIT® 4260 TFS CD**  
 Rectangular Whirlpool or Bathtub



**Features**

- 60" x 42" x 21-1/4" Rectangular whirlpool or bathtub
- Integral apron and tile flange
- Center drain comfort
- Six powerful Ultra-Swirl jets
- Dual air knobs for total jet control
- Limited One-Year Warranty
- Available in Standard Colors: white, almond, biscuit and bone



Model 6126A  
 (Shown with trim upgrade and Lift and Turn drain)



**Options**

**Lift and Turn Drain**

Model #	Description	
PF1320	Polished Chrome	
PF1321	Everbrass (PVD)	
PF1322	Brushed Nickel	
PF1323	Oil Rubbed Bronze	

**Whirlpool Options**

**Metal Trim**

Model #	Description		Model #	Description	
PF1335	Polished Chrome		SWP151	In-line Water Heater	
PF1336	Everbrass (PVD)				
PF1337	Brushed Nickel				
PF1338	Oil Rubbed Bronze				



**MADE IN USA**



# Models 6126A/6627

## PRO-FIT® 4260 TFS CD

Rectangular Whirlpool or Bathtub



### Specifications

Model #	Description	Codes/Standards
6126A	60" x 42" x 21-1/4" Rectangular whirlpool with access panel	  
6627	60" x 42" x 21-1/4" Rectangular bathtub	

Specification	Description	Specification	Description
Material	Acrylic, fiberglass reinforced	Number of Jets	6
Construction	Self-contained, pre-plumbed whirlpool bath, mounted on a pre-leveled base	Water Capacity	42 gal. (min.) / 55 gal. (max.)
Blower Motor	120V, 60HZ, 5.8 amp, single speed, Pre-mounted	Floor Loading Weight	47 lbs. / sq. ft. (229 kg/m <sup>2</sup> )
Electrical Requirements	120V, 15 Amp, GFCI protected circuits	Shipping Weight	whirlpool - 168 lbs. bathtub - 148 lbs.
On/Off Control	Air Switch	Warranty	Limited One Year

### Technical Information

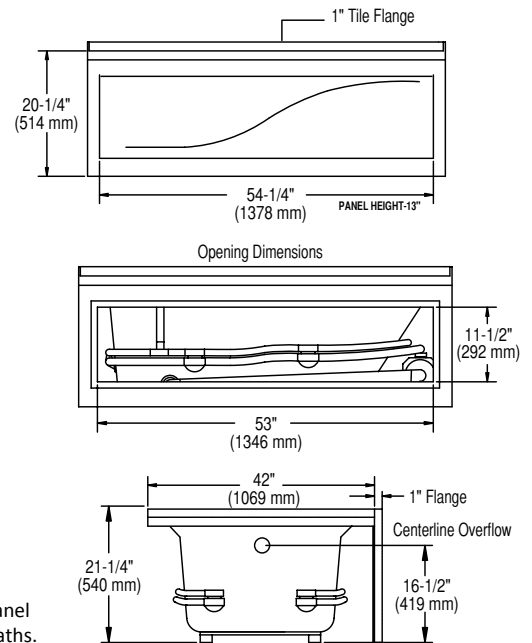
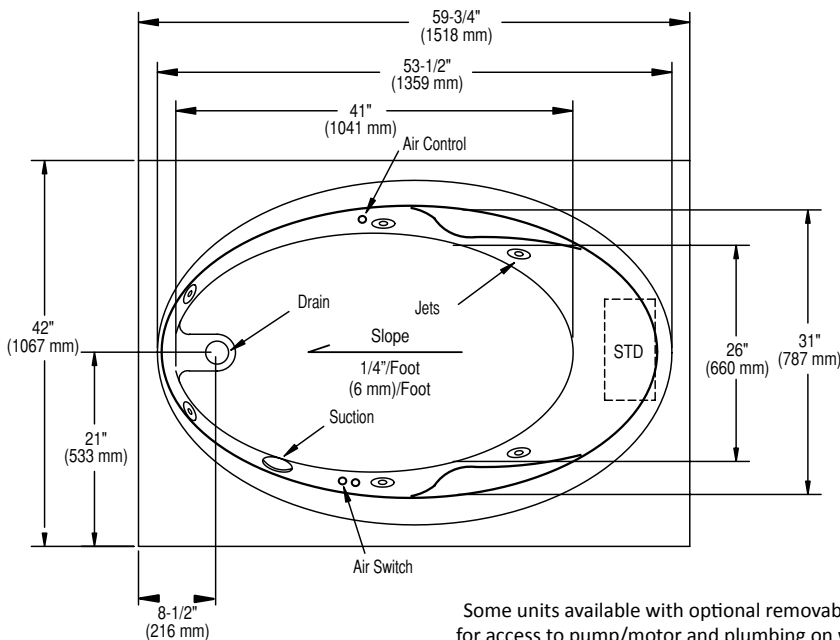

Some units available with optional removable access panel for access to pump/motor and plumbing on whirlpool baths. Specify RH or LH drain when ordering.

Notes: Due to integral tile flange, a nailing flange is not available on this unit.

Measurements may vary 1/4" (+/-)

Install this product according to the installation guide.

These dimensions are nominal and subject to change without notice.

When tested for compliance to the requirements of ASME A112.19.7M for "Whirlpool Bath Appliances" and ANSI Z124.1.2M "American National Standard for Plastic Bathtub and Shower Units", the tested units are found to comply and are acceptable for listing under IAPMO R & T.

Certified for permanent electrical connection only.



**MADE IN USA**