

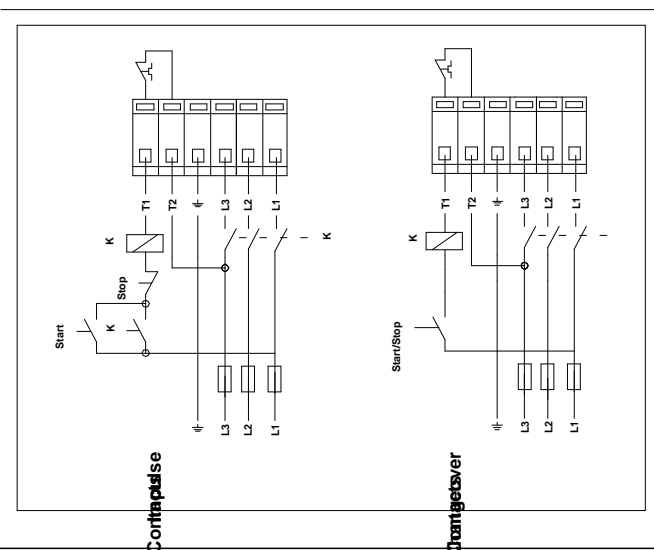

Position	Count	Description	Unit price
	-1	<p>UPS 100-40</p>  <p>Product photo could vary from the actual product</p> <p>Product No.: 96402937 The pump is of the canned rotor type, i.e. pump and motor form an integral unit without shaft seal and with only two gaskets for sealing. The bearings are lubricated by the pumped liquid.</p> <p>In order to avoid problems in connection with disposal, great importance has been attached to using as few different materials as possible.</p> <p>The pump is characterized by:</p> <ul style="list-style-type: none"> * 3-speed motor. * Ceramic radial bearings. * Carbon axial bearing. * Stainless steel rotor can, bearing plate and rotor cladding. * Aluminium alloy stator housing. * Bronze pump housing. * Stator with built-in thermal switch. <p>The motor is a 3-phase motor.</p> <p>The pump is supplied with a standard module in the terminal box. The standard module is to be connected to the mains supply via external contactor.</p> <p>Controls: Relay: without relay</p> <p>Liquid: Liquid temperature range: 14 .. 248 °F Liquid temp: 68 °F</p> <p>Technical: Actual calculated flow: 116 US gpm Resulting head of the pump: 9.42 ft Maximum operating pressure: 145 psi Approvals on nameplate: CUL</p>	On request

Position	Count	Description	Unit price
		<p>Materials:</p> <p>Pump housing: Bronze DIN W.-Nr. 2.1176.01</p> <p>Impeller: Stainless steel DIN W.-Nr. 1.4301 AISI 304</p> <p>Installation:</p> <p>Range of ambient temperature: 32 .. 104 °F Maximum operating pressure: 145 psi Flange standard: ANSI Type of connection: F Pipe connection: 100 Pressure stage: 145 psi Port-to-port length: 21" mm</p> <p>Electrical data:</p> <p>Power input in speed 1: 390 W Power input in speed 2: 435 W Max. power input: 570 W Main frequency: 60 Hz Rated voltage: 3 x 208-230 V Current in speed 1: 1.24 A Current in speed 2: 1.38 A Current in speed 3: 2.5 A Cos phi in speed 1: 0,43 Cos phi in speed 2: 0,41 Cos phi: 0,29 Enclosure class (IEC 34-5): X4D Insulation class (IEC 85): H</p> <p>Others:</p> <p>Net weight: 140 lb Gross weight: 165 lb Shipping volume: 2.51 ft³</p>	

Description	Value
Product name:	UPS 100-40 F B
Product Number:	96402937
EAN number:	5700390686628
Technical:	
Speed Number:	3
Actual calculated flow:	116 US gpm
Resulting head of the pump:	9.42 ft
Head max:	13.1 ft
Maximum operating pressure:	145 psi
Approvals on nameplate:	CUL
Model:	C
Materials:	
Pump housing:	Bronze
	DIN W.-Nr. 2.1176.01
Impeller:	Stainless steel
	DIN W.-Nr. 1.4301
	AISI 304
Installation:	
Range of ambient temperature:	32 .. 104 °F
Maximum operating pressure:	145 psi
Flange standard:	ANSI
Type of connection:	F
Pipe connection:	100
Pressure stage:	145 psi
Port-to-port length:	21" mm
Liquid:	
Liquid temperature range:	14 .. 248 °F
Liquid temp:	68 °F
Electrical data:	
Power input in speed 1:	390 W
Power input in speed 2:	435 W
Max. power input:	570 W
Main frequency:	60 Hz
Rated voltage:	3 x 208-230 V
Current in speed 1:	1.24 A
Current in speed 2:	1.38 A
Current in speed 3:	2.5 A
Cos phi in speed 1:	0,43
Cos phi in speed 2:	0,41
Cos phi:	0,29
Enclosure class (IEC 34-5):	X4D
Insulation class (IEC 85):	H
Motor protection:	CONTACT
Thermal protec:	external
R:	27.5 - 36.0 ohm
Controls:	
Relay:	without relay
Pos term box:	1.30H
Others:	
Net weight:	140 lb
Gross weight:	165 lb
Shipping volume:	2.51 ft ³
Sales region:	Namreg

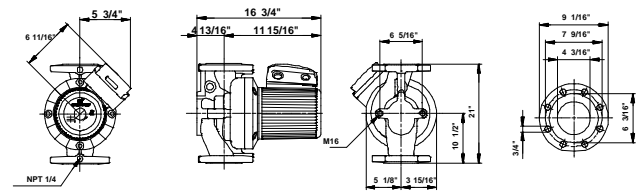
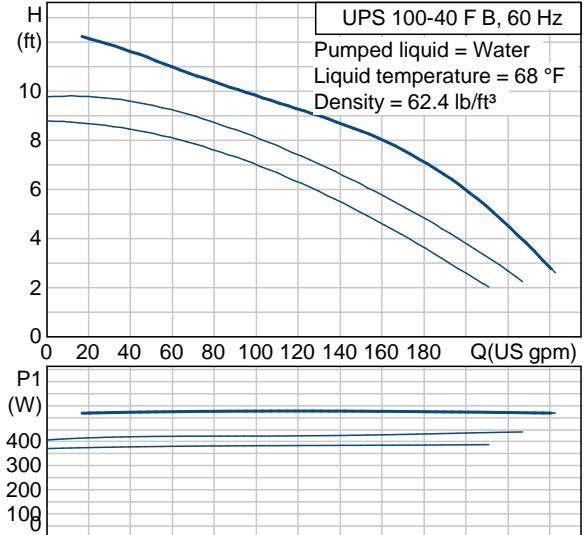

96402937 UPS 100-40 F B 60 Hz

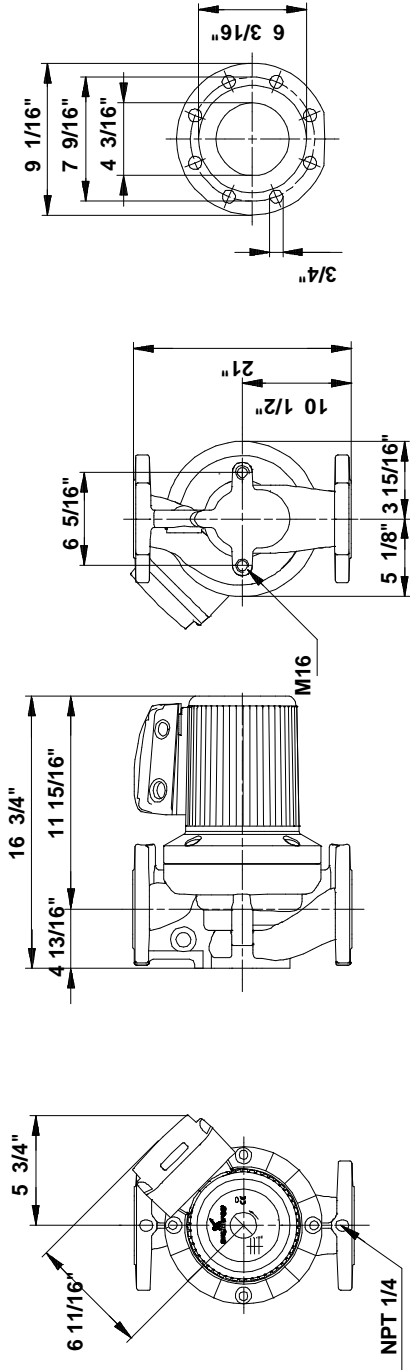

Note! All units are in [mm] unless others are stated.
 Disclaimer: This simplified dimensional drawing does not show all details.