

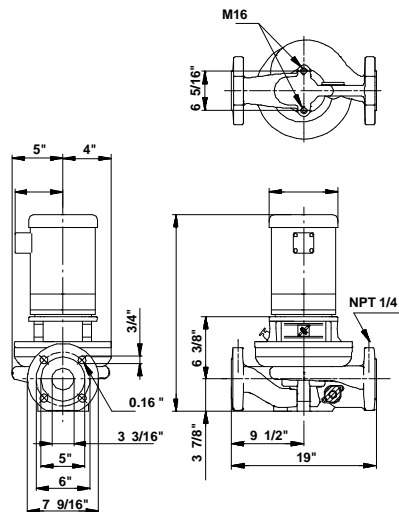

Position	Count	Description	Unit price
	-1	<p>TP 80-80/4 U-G-Z-BUBE</p>  <p>Product photo could vary from the actual product</p> <p>Product No.: 91122133 Single-stage centrifugal in-line single-head pump.</p> <p>The in-line design with opposite suction and discharge ports enables mounting in pipework or on a concrete foundation.</p> <p>The shaft seal is a corrosion-resistant maintenance-free mechanical seal.</p> <p>Liquid: Liquid temperature range: 5 .. 284 °F Liquid temp: 68 °F</p> <p>Technical: Actual calculated flow: 163 US gpm Resulting head of the pump: 20.7 ft Shaft seal: BUBE Maximum operating pressure: 145 psi</p> <p>Materials: Pump housing: Bronze DIN W.-Nr. 2.1093 Impeller: Stainless steel DIN W.-Nr. 1.4301 AISI 304</p> <p>Installation: Maximum operating pressure: 145 psi Flange standard: ANSI Pipe connection: 3" Pressure stage: 125 Lb.</p> <p>Electrical data: Number of poles: 4 Power (P2) required by pump: 1.48 HP Main frequency: 60 Hz</p>	On request

Description	Value
Product name:	TP 80-80/4 U-G-Z-BUBE U-G-Z BUBE
Product Number:	91122133
EAN number:	5700394584395
Technical:	
Actual calculated flow:	163 US gpm
Resulting head of the pump:	20.7 ft
Head max:	26.2 ft
Shaft seal:	BUBE
Maximum operating pressure:	145 psi
Pump version:	U
Materials:	
Pump housing:	Bronze DIN W.-Nr. 2.1093
Impeller:	Stainless steel DIN W.-Nr. 1.4301 AISI 304
Material code:	Z
Installation:	
Maximum operating pressure:	145 psi
Flange standard:	ANSI
Connect code:	G
Pipe connection:	3"
Pressure stage:	125 Lb.
Liquid:	
Liquid temperature range:	5 .. 284 °F
Liquid temp:	68 °F
Electrical data:	
Number of poles:	4
Power (P2) required by pump:	1.48 HP
Main frequency:	60 Hz
Others:	
Country code:	Namreg

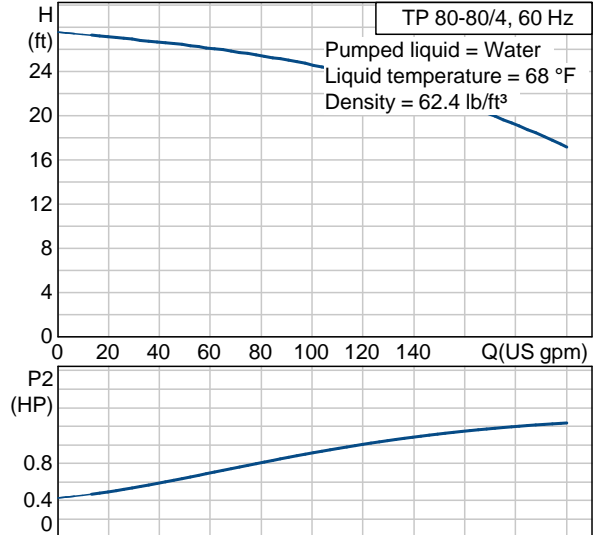

91122133 TP 80-80/4 60 Hz

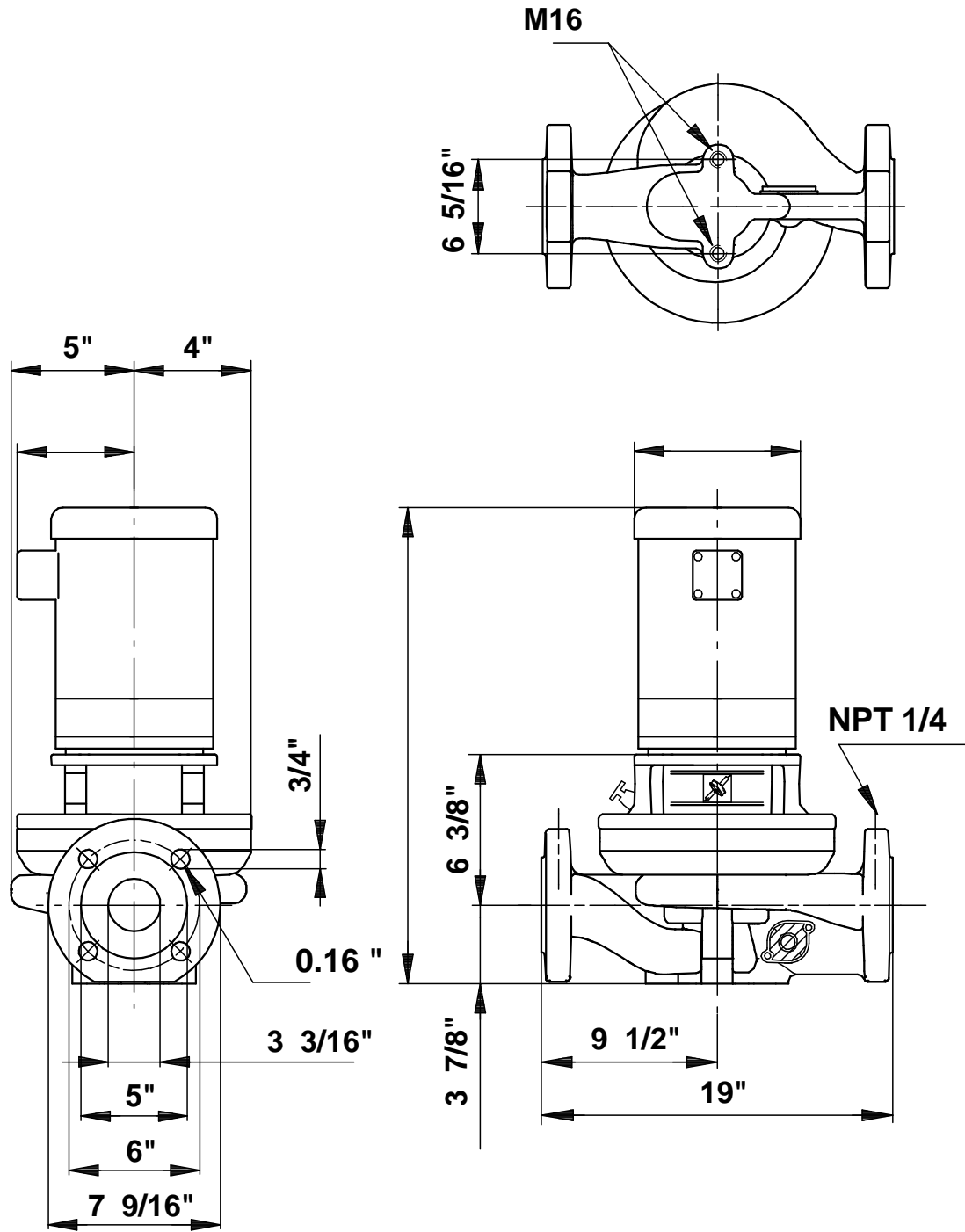

Note! All units are in [mm] unless others are stated.
 Disclaimer: This simplified dimensional drawing does not show all details.