



86__T1__ __ series

Write purchase model number here for future reference

NOTE: For optimum performance of this product, we recommend a system pressure between 20 and 80 PSI static. This product will operate up to a maximum of 125 PSI static per ANSI and CSA requirements. However, we do not recommend pressure above 80 PSI. Thermal expansion or leaking pressure reducing valves may require use of expansion tanks or relief valves to ensure your system never exceeds its maximum intended pressure setting.

ELECTRONIC PUSH BUTTON SHOWER

210066

210066

210066

210066

210066

210066

210066

210066

210066

210066

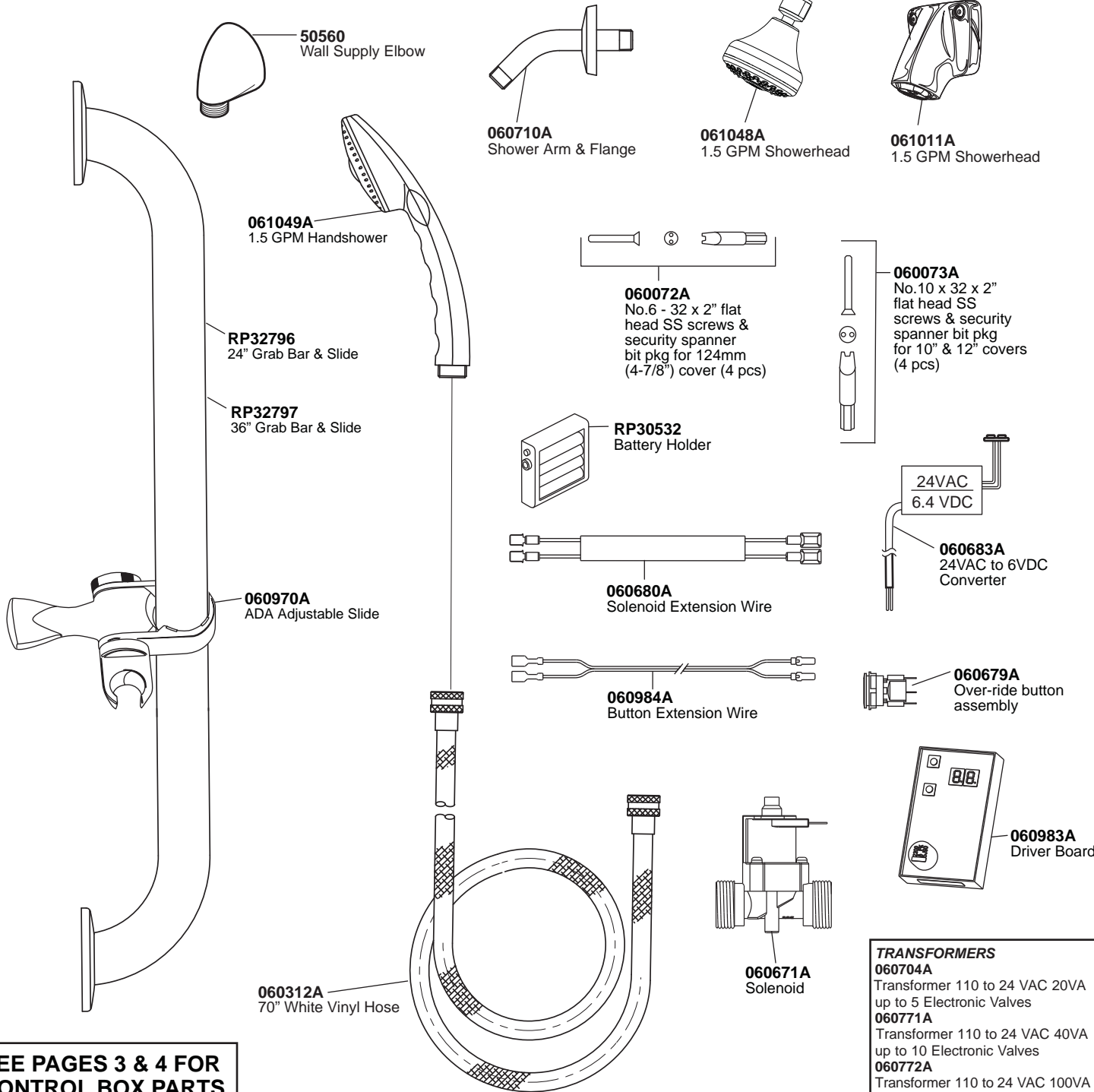

SEE PAGES 3 & 4 FOR CONTROL BOX PARTS

PLEASE LEAVE this M&I Sheet with the owner, maintenance plumber, etc. as items relating to ongoing maintenance suggestions and procedures are included.

**Installation should be in accordance with local plumbing and electrical codes.
FLUSH ALL PIPES THOROUGHLY BEFORE INSTALLATION.**

INSTALLATION INSTRUCTIONS

STEP 1 - ROUGH IN

- Remove suitable knockout(s) in box(es) and insert cable bushing(s). See Fig.1. NOTE: Wires connecting between boxes and from the transformer must be protected from abrasion and being pulled at connections. They also may have to be finished through at a later stage of construction. Depending on the installation, the cable bushings included may be replaced by installer supplied 1/2" conduit.
- Rough in box as per Fig.3. Use Figures 4, 5, 6 and 7 for specific box information.
- For Hardwire Models:** Install CSA and/or UL approved Class 2 transformer or equivalent in a convenient location or in a pipe chase. **(DO NOT install the transformer inside the control box.)** The transformer is to be installed in an adjacent accessible space. Cable from the transformer to the control box may be roughed in at this time depending on installation. Use cable which complies with local electrical codes for a 1 amp load. No.18 cable is usually sufficient.

STEP 2 - CONNECT SHOWER

- Connect piping from supply to valves as per applicable Figure 4, 5, 6 or 7 and for shower head (Fig. 2).
- Finish drainage system and walls.

STEP 3 - FLUSH SYSTEM

- Install shower outlet.
- Open screw driver stop(s) to flush installation for 30 seconds. If pressure balancing valve is supplied, use supplied handle to rotate the valve stem midway between its stops before flushing. If thermostatic mixing valve is supplied, move lever to central position before flushing.
- Close stops.

Fig. 1

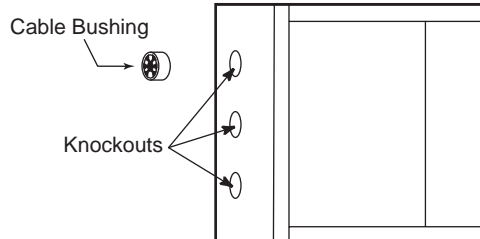
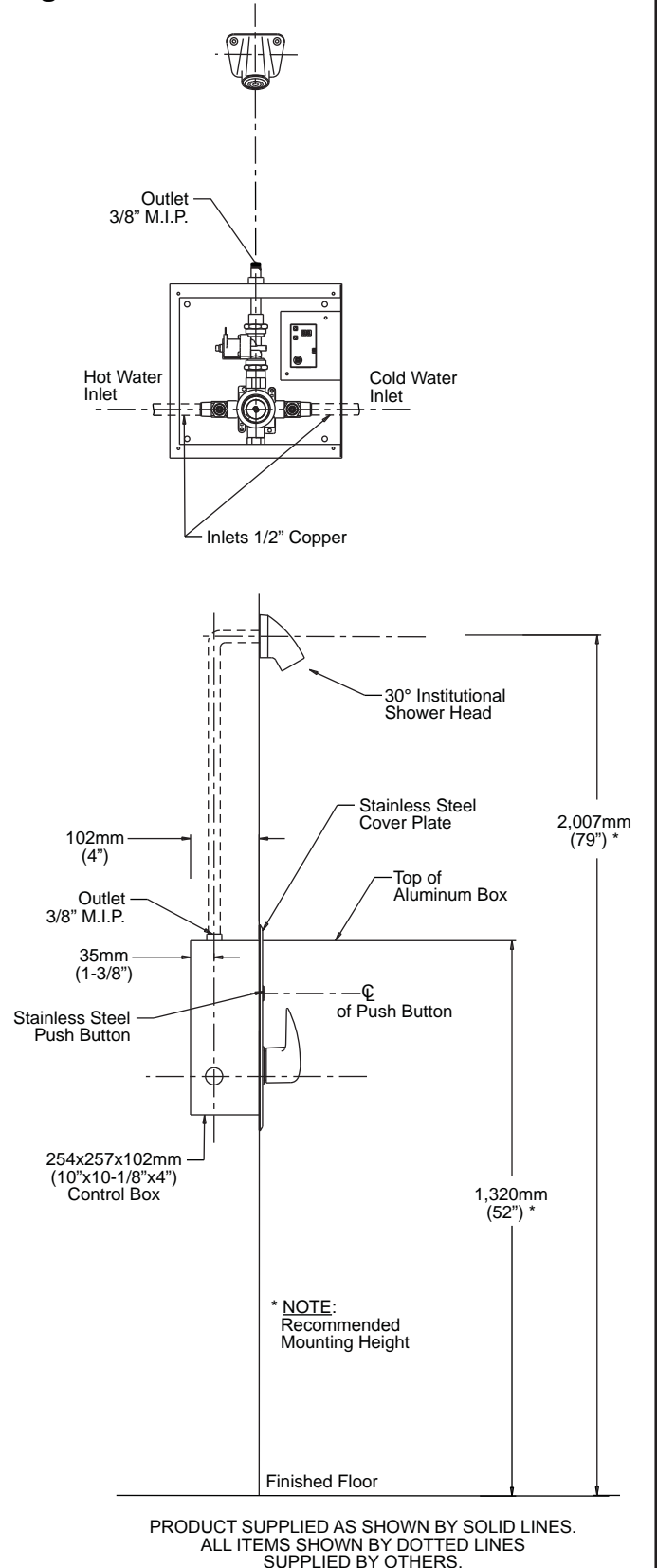

Fig. 2



INSTALLATION INSTRUCTIONS

Fig. 3

Typical Installations

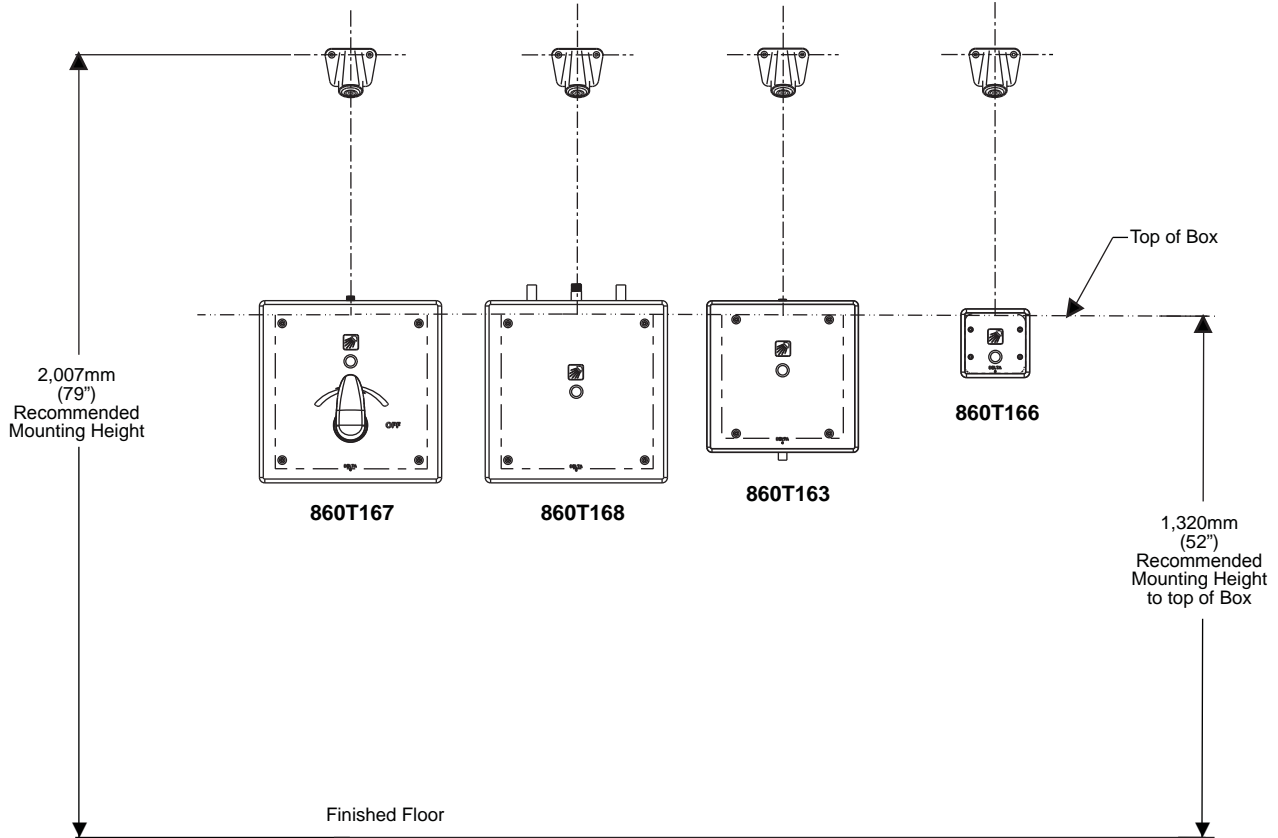

Fig. 4

Control Box #6

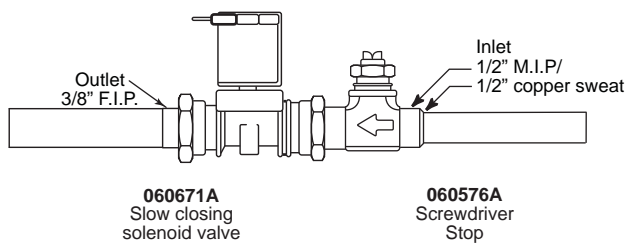
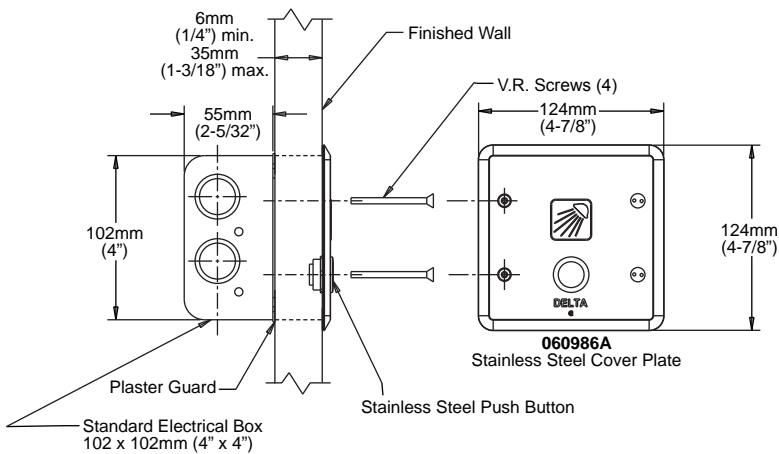
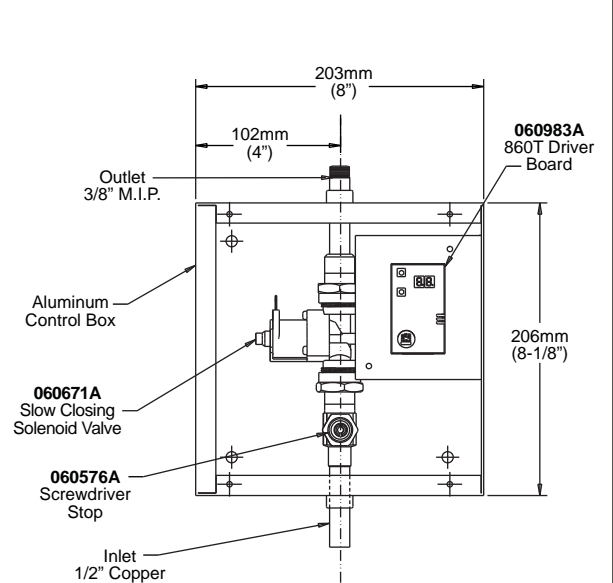

Fig. 5

Control Box #3



Tempered Water (By Others)

060985A 10" x 10" Stainless Steel Cover

INSTALLATION INSTRUCTIONS

Fig. 6 Control Box #7

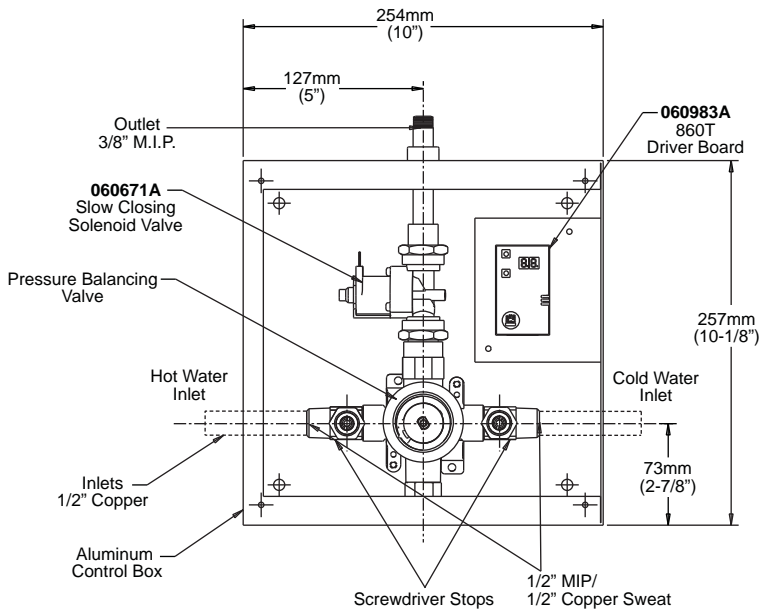

PIPING SHOWN WITH DOTTED LINES SUPPLIED BY OTHERS.

060987A
12" x 12" Stainless Steel Cover

Fig. 7 Control Box #8

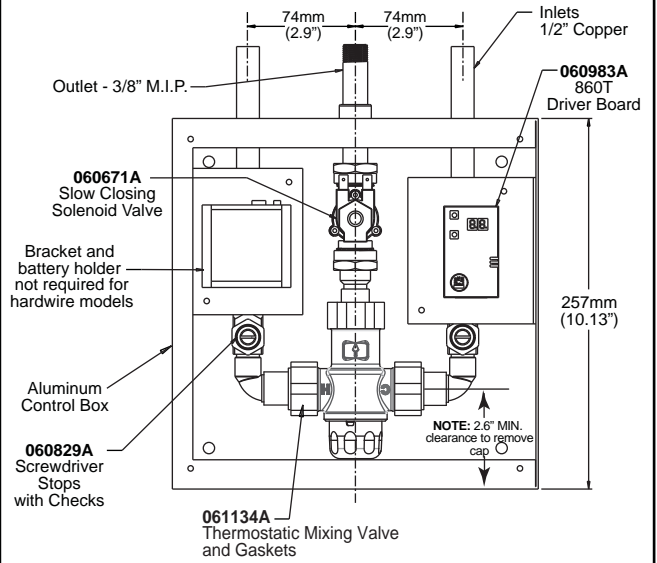

060988A
12" x 12" Stainless Steel Cover

TMV Repair Kits

061135A
Gasket Kit only (3 pcs)

061137A
Adjustment Wrench

Parts for Pressure Balance Mixing Valve

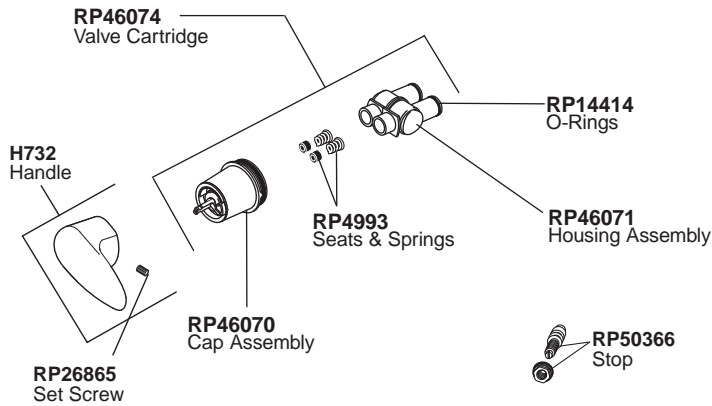

INSTALLATION INSTRUCTIONS

STEP 4 - CONNECT DRIVER BOARD, SOLENOID, POWER SUPPLY AND OVERRIDE BUTTON

- Remove valve spacer and replace with solenoid valve (Fig. 9). Note flow direction marked on the valve body and install in the correct orientation (Fig. 8).
- Attach the black and red solenoid wires on the driver board to the solenoid. Red wire attaches to the terminal marked "+", Black wire to "-".
- For Battery -
 - Install 4 fresh "AA" batteries into the battery pack.
 - Attach the driver board battery clip to the battery pack.
- For Hardwire - ⚠️
 - Install CSA and/or UL approved class 2 transformer or equivalent in a convenient location in an adjacent accessible space, either above the ceiling or in an access chase.
 - Have transformer connected to the power supply as required by local electrical codes.
 - Run cable from the secondary side of the transformer to the control box, if not already done, and connect to the hardwire converter (060683A).
- Attach the driver board battery clip to the hardwire converter.
- Override Button -
 - Use the supplied button extension wire and connect the male ends to the override button wires (yellow) of the driver board.
 - Connect the female ends of the extension cord to the stainless steel button (Fig. 10).

Fig. 8

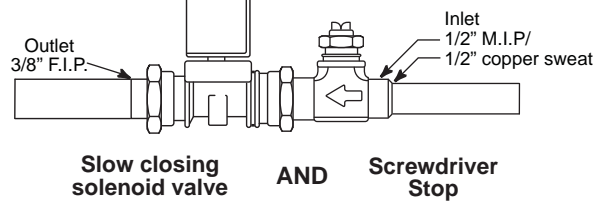
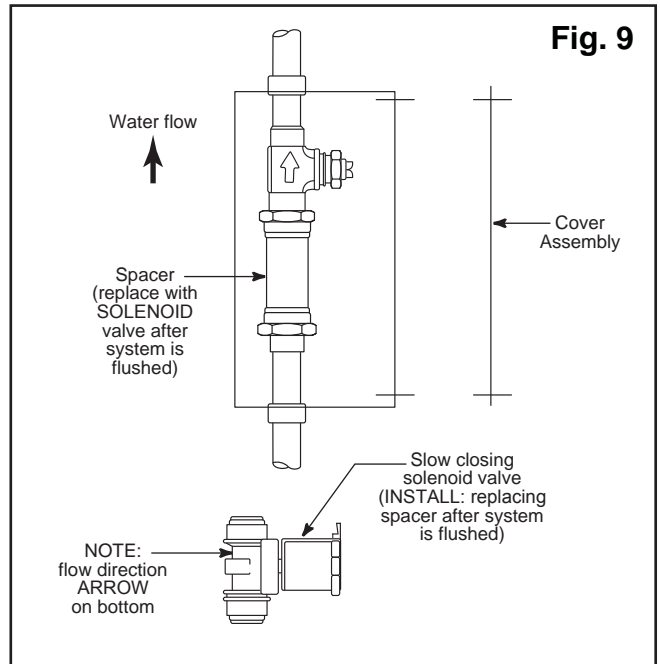

Fig. 9



STEP 5 - TURN ON WATER, ADJUST AND REPLACE COVERS

5.1 Pressure Balanced Valve

- Install cartridge. (Note: for cartridge installation instructions and back to back installations, refer to pages 3 to 6 of the included MultiChoice™ Valve Trim instructions.)
- Open screwdriver stop(s) to supply water to the shower.
- Press the stainless steel button to start the flow of water.
- Adjust to desired water temperature (page 6 of the MultiChoice™ Valve Trim instructions).
- Ensure that the stickers contained within the MultiChoice™ Valve Trim instructions are applied accordingly.
- Advance to step 5.3.

5.2 Thermostatic Mixing Valve

- To adjust the mixed outlet temperature of the valve, remove the cap to gain access to the adjusting spindle.
- The spindle should be rotated towards the "C" side to reduce the temperature and towards the "H" side to increase the temperature - until the desired set point is reached (refer to Fig. 11).

Periodic Inspection/Maintenance

- We recommend that this valve is checked at least once per year to ensure its continued function. For installations with poor or unknown water quality, or other adverse supply conditions, it may be necessary to check the valve at more frequent intervals. The temperature should be checked at the same outlet as was used for commissioning in the first instance. If the temperature is more than 3°F from the commissioning in temperature, refer to the included Cash Acme Maintenance & Installation Guide.

5.3 All Models

- Replace covers using vandal resistant screws and drivers supplied.

Fig. 10

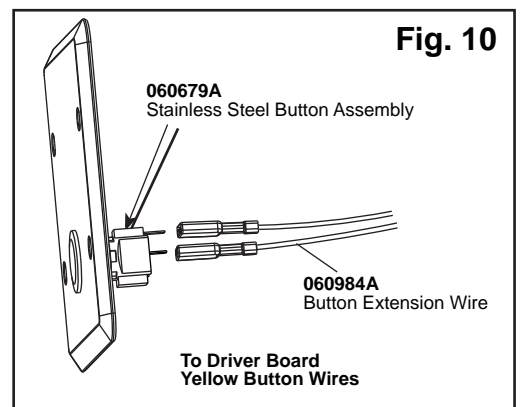
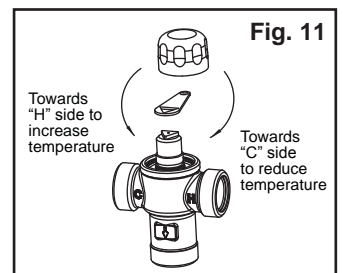

Fig. 11



OPERATION

- Shower flows when stainless steel button is activated.
- Shower flow stops upon reactivation of the button, or when the maximum continuous run time expires. Default continuous run time is 3 minutes. Refer to Driver Board Set-Up section for information on how to adjust the maximum continuous run time.
- When the run time expires and the shower turns off, the user may press the override button again to obtain an additional 2 minutes of run time.
- Adjustable maximum run time from 1 minute to 10 minutes - in 30 second increments.
- Battery operated units - the electronics of the shower driver board have been optimized for maximum battery life. On a set of 4 "AA" alkaline batteries, users should expect up to 5 years of battery service. To check the status of the battery life without the need of a multi-meter, do the following:
 1. Ensure nothing is showing on the display screen. If there are numbers being displayed on the screen, simply wait a few seconds until the screen goes blank.
 2. Press and hold down the "UP" button.
 3. The display will then highlight an appropriate amount of bars to signify the strength of the batteries. The number of bars displayed is proportionate to the "health" of the batteries. For example:



3 BARS - batteries are healthy. 3 - 5 years of service life left (depending on shower usage).



2 BARS - batteries are okay. 1 - 3 years of service life left (depending on shower usage).



1 BAR - batteries will need to be replaced soon. Less than a year of service life left (depending on shower usage).



NO BARS (dot in lower-right corner) - batteries need to be replaced immediately. The solenoid has been locked out and will not fire until batteries have been replenished.

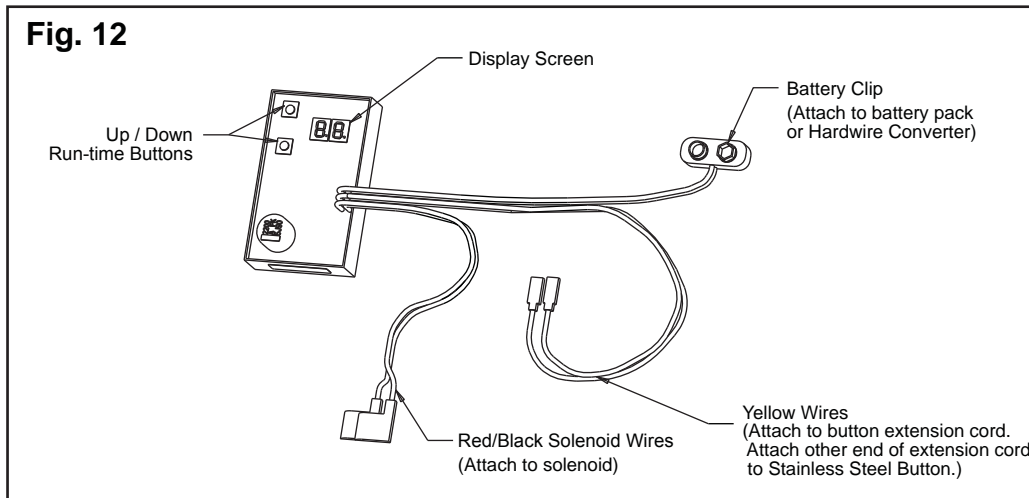

DRIVER BOARD SET-UP

- Press the yellow up and down buttons (Fig. 12) at any time to increment or decrement the maximum run time of the shower. The maximum run time is adjustable from 1 minute to 10 minutes - in 30 second increments.
- Use the display (Fig. 12) to verify that the maximum run time you want has been set.
- A “.5” at the end of a number signifies an additional 30 seconds.
Example : 6.5 = 6 minutes and 30 seconds
- There are also 0.1, 0.2, 0.5 and 0.7 settings which are lower than 1 minute. These settings are not recommended for this shower system.

Display Status	Max. Run Time
10	10 minutes
9.0	9 minutes
8.0	8 minutes
7.0	7 minutes
6.0	6 minutes
5.0	5 minutes
4.0	4 minutes
3.0	3 minutes
2.0	2 minutes
1.0	1 minute
0.7	42 seconds *
0.5	30 seconds *
0.2	12 seconds *
0.1	6 seconds *

* not recommended for shower system

CARE INSTRUCTIONS

This Delta Commercial product is designed and engineered in accordance with the highest quality and performance standards. With proper care, it will give years of trouble free service. Care should be given to the cleaning of this product. Although the chrome finish is extremely durable, it can be DAMAGED by ACIDIC CLEANERS (i.e., cleaners designed specifically for vitreous china lavatories and water closets), HARSH ABRASIVES or POLISH. To clean, simply wipe the surface with a damp cloth and blot dry with a soft cloth.

TROUBLE SHOOTING GUIDE

If shower does not come on when button is activated:

1. Verify that the water is on, screwdriver stop(s) are open and the temperature control valve is open.
2. Check to see that the plugs for the stainless steel button and solenoid valve are pushed in properly. Also ensure no bare wires are touching one another, possibly shorting out the button.
3. Verify that the battery clip is hooked up to a 6 volt DC supply - either the battery pack or the hardwire converter. If battery pack is below 4 volts DC, then replace with 4 new “AA” alkaline batteries. To check the status of the batteries without the need of a multi-meter, refer to page 6.
4. Remove solenoid and filter screen from solenoid valve and check for dirt deposits.

If water flows continuously:

1. Maximum run time may be set too high. Refer to “**Driver Board Set-Up**” on how to lower the maximum run time of the shower.
Note: The shower will run continuously until the maximum run time has expired, OR until a user presses the stainless steel button.
2. Ensure that the solenoid wires are hooked up correctly. Red wire to “+” marking solenoid, black wire to “-”.

Backflow Protection System

Your Delta handshower incorporates a backflow prevention system that has been tested to be in compliance with ASME A112.18.3, CSA B125.1 and ASME A112.18.1. It incorporates two certified check valves in series, which operate independently and are integral, non-servicable parts of the wand assembly. In jurisdictions where code may not allow this device, order vacuum breaker separately.

Delta Commercial Faucet Limited Warranty

All parts of the Delta® HDF® and TECK® faucets are warranted to the original consumer purchaser to be free from defects in material, finish and workmanship for a period of five (5) years unless otherwise specifically stated in the catalogue and price book. This warranty is made to the original consumer purchaser and shall be effective from date of purchase as shown on purchaser's receipt.

Delta will, at its option, repair or replace, FREE OF CHARGE, during the warranty period, any part which proves defective in material or workmanship under normal installation, use and water and service conditions. If Delta Faucet concludes that the returned part was manufactured by Delta Faucet and is, in fact, defective, then Delta Faucet will honour the warranty stated herein. Replacement parts can be obtained from your local dealer or distributor listed in the telephone directory or by returning the part along with the purchaser's receipt to our factory, TRANSPORTATION CHARGES PREPAID, at the address listed. THIS WARRANTY IS THE ONLY EXPRESS WARRANTY MADE BY DELTA. ANY CLAIMS MADE UNDER THIS WARRANTY MUST BE MADE DURING THE FIVE YEAR PERIOD REFERRED TO ABOVE. ANY IMPLIED WARRANTIES, INCLUDING THE IMPLIED WARRANTY OF MERCHANTABILITY OF FITNESS FOR A PARTICULAR PURPOSE, ARE LIMITED IN DURATION TO THE DURATION OF THIS WARRANTY. LABOUR CHARGES AND/OR DAMAGE INCURRED IN INSTALLATION, REPAIR OR REPLACEMENT AS WELL AS INCIDENTAL AND CONSEQUENTIAL, SPECIAL, INDIRECT OR PUNITIVE DAMAGES CONNECTED THEREWITH ARE EXCLUDED AND WILL NOT BE PAID BY DELTA FAUCET.

Some states do not allow limitations on how long an implied warranty lasts, or the exclusion or limitation of incidental or consequential damages, so the above limitations or exclusions may not apply to you. This warranty gives you specific legal rights, and you may also have other rights which vary from state to state.

This warranty is for commercial products only from Delta Faucet Company and Delta Faucet Canada (a division of Masco Canada Limited) and is void for any damage to this faucet due to misuse, abuse, neglect, accident, improper installation, any use in violation of instructions furnished by Delta Faucet or any use of replacement parts other than genuine Delta parts.

Garantie Limitée Delta Commercial

Toutes les pièces des robinets de marque Delta® HDF® et TECK® sont garanties contre tout défaut de matériel, de finition et de main-d'oeuvre pour une période de cinq (5) ans, sauf indication contraire stipulée dans le catalogue et la liste des prix. Cette garantie est offerte à l'acheteur original et entre en vigueur à compter de la date d'achat indiquée sur la preuve d'achat.

Delta procédera, à son entière discrétion, à la réparation ou au remplacement, SANS FRAIS, durant la période de garantie, de toute pièce qui présente un défaut de matériel ou de main-d'oeuvre dans des conditions d'installation, d'usure, d'eau et de service normales. Si Delta Faucet détermine que la pièce retournée a été fabriquée par Delta Faucet et qu'en effet, cette pièce défectueuse, Delta Faucet respectera alors la garantie mentionnée ci-dessous. Les pièces de rechange peuvent être obtenues chez votre marchand local ou le distributeur inscrit dans votre annuaire téléphonique, ou en retournant la pièce ainsi que la preuve d'achat à notre usine, FRAIS DE TRANSPORT PRÉPAYÉS, à l'adresse indiquée. CETTE GARANTIE EST LA SEULE GARANTIE EXPRESSE FAITE PAR DELTA.

TOUTE RÉCLAMATION FAITE EN VERTU DE CETTE GARANTIE DOIT ÊTRE PRÉSENTÉE DURANT LA PÉRIODE DE CINQ ANS MENTIONNÉE CI-DESSUS. TOUTE GARANTIE IMPLICITE, Y COMPRIS LA GARANTIE IMPLICITE DE VALEUR COMMERCIALE D'ADÉQUATION POUR UN USAGE PARTICULIER, EST LIIMITÉE DANS LE TEMPS À LA DURÉE DE LA PRÉSENTE GARANTIE.

LES FRAIS DE MAIN-D'OEUVRE ET/OU LES DOMMAGES ENCOURUS DURANT L'INSTALLATION, LA RÉPARATION OU LE REMPLACEMENT AINSI QUE LES DOMMAGES ACCIDENTELS ET CONSÉCUTIFS, SPÉCIAUX, INDIRECTS OU PUNITIFS QUI SONT RELIÉS SONT EXCLUS ET NE SERONT PAS PAYÉS PAR DELTA FAUCET.

Certains états ne permettent pas la limitation de la durée de la garantie implicite, ou l'exclusion ou la limitation des dommages accidentels ou consécutifs, et par conséquent, les limitations ou les exclusions stipulées ci-dessus peuvent ne pas s'appliquer dans votre cas. Cette garantie vous accorde certains droits reconnus par la loi et vous pouvez aussi avoir d'autres droits qui varient d'un état à l'autre.

Cette garantie s'applique seulement aux produits commerciaux de Delta Faucet Company et Delta Faucet Canada (une filiale de Masco Canada Limited) et est nulle de plein droit pour tout dommage causé à ce robinet en raison d'une mauvaise utilisation, d'abus, de négligence, d'accident, de mauvaise installation, pour tout usage en contravention des directives fournies par Delta Faucet ou pour tout usage de pièces de rechange autres que des pièces originales Delta.

Garantía Limitada de las Llaves de Agua Comerciales Delta

Todas las piezas de las llaves de agua (grifos) Delta® HDF®, TECK® están garantizadas al comprador consumidor original de estar libres de defectos de material, acabado y fabricación por un periodo de cinco (5) años a menos que sea establecido específicamente de otra manera en el catálogo o libro de precios. Esta garantía se le otorga al comprador consumidor original y será efectiva desde la fecha de compra indicada en el recibo del comprador.

Delta, a su opción, reparará o reemplazará, GRATUITAMENTE, durante el periodo de garantía, cualquier pieza que resulte defectuosa en material o fabricación bajo instalación, uso, agua y condiciones de servicio normales. Si Delta Faucet concluye que la pieza devuelta fue fabricada por Delta Faucet y es, de hecho, defectuosa, entonces Delta Faucet honrará la garantía establecida en este documento.

Las piezas de reemplazo se pueden obtener de su tienda o distribuidor local listado en la guía telefónica o devolviendo la pieza junto con el recibo de compra a nuestra fábrica, CON LOS GASTOS DE ENVÍO PRE-PAGADOS, a la dirección indicada. ESTA GARANTÍA ES LA ÚNICA GARANTÍA EXPRESA HECHA POR DELTA. CUALQUIER RECLAMO HECHO BAJO ESTA GARANTÍA DEBE SER HECHO DURANTE EL PERÍODO DE CINCO AÑOS ARRIBA MENCIONADO. CUALQUIER GARANTÍA IMPLÍCITA, INCLUYENDO LA GARANTÍA IMPLÍCITA DE COMERCIABILIDAD DE EMPLEO PARA UN PROPÓSITO PARTICULAR, TIENE UNA DURACIÓN LIMITADA A LA DURACIÓN DE ESTA GARANTÍA. LOS CARGOS DE MANO DE OBRA Y/O DAÑO INCURRIDO DURANTE LA INSTALACIÓN, REPARACIÓN O REEMPLAZO, COMO TAMBIÉN DAÑOS INCIDENTALES O RESULTANTES, ESPECIALES, INDIRECTOS O PUNITIVOS RELACIONADOS CON LO MENCIONADO, QUEDAN EXCLUIDOS Y NO SERÁN CUBIERTOS POR DELTA FAUCET.

Algunos estados no permiten limitaciones de la duración de una garantía implícita, o la exclusión o limitación de daños incidentales o consecuentes, de manera que las limitaciones o exclusiones arriba mencionadas puedan no aplicarse en su caso. Esta garantía le otorga derechos legales específicos, y usted también puede tener otros derechos que varían de estado a estado.

Esta garantía es solo para productos comerciales de Delta Faucet Company y Delta Faucet Canada (una división de Masco Canada Limited), y queda anulada por cualquier daño ocasionado a esta llave de agua resultante del mal uso, abuso, descuido, accidente, instalación incorrecta, cualquier uso en violación de las instrucciones proporcionadas por Delta Faucet o el uso de cualquier parte de repuesto que no sea una parte genuina de Delta.

Delta Faucet Canada, a division of Masco Canada Limited
350 South Edgeware Road, St. Thomas, Ontario, N5P 4L1
1-800-567-3300 (English) 1-800-265-9245 (French)

Delta Faucet Company
Box 40980, 55 East 11th St., Indianapolis, IN, U.S.A. 46280
(317) 848-1812

For further technical assistance, call Delta Commercial Technical Service at 1-800-387-8277.

Pour obtenir de l'assistance technique, appelez le Service Technique de Delta Commercial au 1-800-387-8277.

Por la asistencia técnica adicional, llame al servicio técnico de Delta Comercial al 1-800-387-8277.