



OWNER'S MANUAL & INSTALLATION GUIDE

LUXEAIR SERIES

Note: Read all instructions before proceeding with installation.
All specifications are $\pm 1/4''$ and are subject to change without notice.
Dimensions listed in inches (mm).



TABLE OF CONTENTS

PRODUCT REGISTRATION INFORMATION	3
CONGRATULATIONS!	4
SAFETY INSTRUCTIONS	5
INSTALLATION INSTRUCTIONS	
Pre-Installation Procedures	6
Structural Preparation	7-8
Factory Installed Tile Flange	8
LuxeAir 31 & 32 Integrally Skirted Baths	8
Installation Procedures for Integrally Skirted Models	9
Removable Skirt Panels for Integrally Skirted Models	9
Plumbing	10
Rough-In Measurements	10
Electrical Installation	11-12
Component Breakdown	13-14
OPERATION	
Jet Operations	15
Inline Maintenance Heater Operating Instructions	16
Bathside Control Systems	17-19
To Replace LED Light	20
CARE AND MAINTENANCE	
Initial Cleaning	21
Whirlpool System Cleaning	21
Air Bath System Cleaning	21
Surface Cleaning	21
Jet Cleaning	22
Surface Scratch Removal	22
Repair	22
Water Quality Issues	22-24
User Information	25
FCC Information	25
TROUBLESHOOTING GUIDE	
Symptoms/Possible Problems/Suggested Solutions	26
PARTS ORDER FORM/PARTS MAPS/PARTS LIST	
Replacement Parts Order Form	27
Replacement Parts Maps	28-29
AQUATIC LIMITED WARRANTY	30

AQUATIC

Product Registration Information

Your product warranty is registered and confirmed with Aquatic through the Serial Number on your unit. You do not need to contact Aquatic to confirm registration. Please fill out the information below and reference when contacting the distributor to expedite warranty claims.

OWNER INFORMATION:

Model Name

Serial Number

Purchase Date

Distributor



Model & Serial Number Location

The tub model and serial numbers are located above the pump area on the backside of the bathtub. An access panel should be placed by the installer at this location.



8101 E. Kaiser Blvd. • Anaheim, CA 92808
(800) 945-2726 • Fax (866) 544-5353
www.aquaticbath.com



CONGRATULATIONS!

You have chosen one of the finest bath products in the world! Aquatic supports your purchase with strong commitments to quality and customer satisfaction.

Please read and follow all of the instructions contained in this Owner's Manual before installing, operating or maintaining your whirlpool. In addition, you should continually refer to these instructions during the life of your whirlpool. Failure to comply with these instructions may invalidate your warranty. If you have any questions concerning installation, operation, maintenance or any other aspect of your whirlpool, please contact:

AQUATIC CUSTOMER SERVICE CENTER: 800.945-2726

(The Troubleshooting Guide on page 26 may be helpful in answering some of your questions.)

NOTE:

The installation and service of your whirlpool should be performed **ONLY** by a qualified electrician and plumber.

IMPORTANT!

This product **MUST BE WATER-TESTED** and inspected prior to installation or warranty will be voided. See pre-installation procedures on page 6 for instructions.

PLEASE CHECK ENTIRE UNIT FOR ANY DAMAGE.

If it appears damaged, contact your Aquatic Distributor immediately.
Aquatic warranty does not cover damage that occurs in transit.

SAFETY INSTRUCTIONS

WARNING: WHEN USING THIS UNIT, THESE BASIC PRECAUTIONS SHOULD BE FOLLOWED.

This manual contains information and instructions for proper operation and maintenance of your whirlpool. Failure to follow these instructions could result in personal injury, electrical shock or fire.

READ AND FOLLOW ALL INSTRUCTIONS

DANGER! TO REDUCE THE RISK OF INJURY:

- A. Do not permit children to use this unit unless they are closely supervised by an adult at all times. Supervision is also required when whirlpool bath is used by an elderly or handicapped individual.
- B. Use this unit only for its intended use as described in this manual. Do not use attachments not recommended by the manufacturer.
- C. Do not operate this unit without guard over the suction fitting.
- D. The water in a whirlpool should never exceed 40°C (104°F). Water temperatures between 38°C (100°F) and 40°C (104°F) are considered safe for a healthy adult. Use time should be limited to approximately 30 minutes, followed by a shower to cool down. Longer exposures may result in hyperthermia. The symptoms of this condition are nausea, dizziness and fainting, which can be fatal. Lower water temperatures are recommended for extended use (exceeding 10 - 15 minutes) and for young children.
- E. Since excessive water temperatures have a high potential for causing fetal damage during the early months of pregnancy, pregnant or possibly pregnant women should limit whirlpool water temperatures to 38°C (100°F).
- F. The use of drugs or alcoholic beverages before or during whirlpool use may lead to unconsciousness with the possibility of drowning. Never use the whirlpool while under the influence of alcohol, anticoagulants, stimulants, antihistamines, vasoconstrictors, vasodilators, hypnotics, narcotics or tranquilizers.
- G. Persons with a medical history of heart disease, low or high blood pressure, circulatory system problems, or diabetes should consult a physician before using a whirlpool.
- H. Persons using medication should consult a physician before using a whirlpool since medication may induce drowsiness while other medication may affect heart rate, blood pressure and circulation.

DANGER: To reduce the risk of injury, enter and exit the bath slowly.

WARNING: Never operate electrical devices in or near the bath. Never drop or insert any object into any opening within the whirlpool.

This unit must be connected to a supply circuit that is protected by a Ground Fault Circuit Interrupter (GFCI). Such a device should be installed by a licensed electrician and should be tested on a regular basis (at least monthly). To test the GFCI push the **TEST** button. The GFCI should interrupt the power. Push the **RESET** button and the power should be restored. If the GFCI fails to operate in this manner there is the possibility of an electric shock. **DO NOT USE.** Disconnect the unit and have the problem corrected by a qualified service technician. To avoid the possibility of personal injury and discoloration of the acrylic surface, the inlet water temperature should not exceed 60°C (140°F). The bath should be drained after each use. Each bather should start their bath with fresh water.

CAUTION: do not use harsh abrasives or solvents for cleaning this unit.

INSTALLER/OWNER BEARS ALL RESPONSIBILITY TO COMPLY WITH ALL STATE AND LOCAL CODES WHEN INSTALLING THIS PRODUCT.

INSTALLATION INSTRUCTIONS

READ ALL INSTRUCTIONS CAREFULLY BEFORE INSTALLATION

PRE-INSTALLATION PROCEDURES

WARNING: All units are shipped with loose unions. Before attempting to test, install or use your whirlpool, all pump and heater unions and "O" rings must be repositioned and/or tightened.

PLEASE NOTE: THE MANUFACTURER ACCEPTS A 1/4" VARIANCE. THERE ARE VARIATIONS ON EACH TUB AND SPECIFICATIONS ARE SUBJECT TO CHANGE AS WE IMPROVE UPON OUR PRODUCT AS REQUIRED.

THE DIMENSIONS NEEDED FOR SITE PREPARATION AND STRUCTURE BUILDINGS SHOULD BE MEASURED FROM THE TUB; AQUATIC, ASSUMES NO RESPONSIBILITY FOR PREPARATORY WORK.

Note: A good knowledge of construction techniques, plumbing and electrical installation according to codes are required for proper installation. We recommend that a qualified licensed contractor perform the installation of all Aquatic products. Our warranty does not cover improper installation related problems.

1. Immediately upon receiving your Aquatic, whirlpool bath inspect it thoroughly for freight damage. If necessary, contact your dealer/distributor immediately (your dealer/distributor must contact Aquatic, within 24 hours of receiving unit to file a claim.) Should inspection indicate any damage, do not install the bath.
2. All baths are filled with water and operated in our manufacturing facility prior to shipment. Inspectors ensure watertight operation, however, rough handling may cause leaks which may be detected prior to installation.

DAMAGE OR DEFECT TO THE FINISH CLAIMED AFTER THE BATH IS INSTALLED IS NOT COVERED UNDER THE WARRANTY.

To inspect:

3. Place the tub in an area where it may be drained after testing.
4. Fill the tub with hot water (approximately 100° F) to the overflow and allow to stand for a few minutes. Carefully inspect all fittings and connections for leaks.
5. Plug in pump and blower cords and run pump for 10 minutes.
6. With the pump running, turn on the blower. Check all functions.
7. Inspect the tub completely. Any defect must be reported to Aquatic, prior to installation in order to have it covered by warranty. Should inspection indicate any damage, do not install the bath.
8. Check to ensure that your installation will conform to all applicable codes and secure necessary permits. All electrical and plumbing connections should be made by qualified electricians and plumbers.

DAMAGE OR LEAKS CLAIMED AFTER THE BATH IS INSTALLED ARE NOT COVERED UNDER THE WARRANTY.

WARNING: FAILURE TO FOLLOW THESE INSTRUCTIONS DURING INSTALLATION WILL RESULT IN TERMINATION OF THE WARRANTY:

Do not lift the tub by any portion of the plumbing or pump.
Do not stand in the tub during construction.

DO NOT MAKE ANY ALTERATIONS, ADDITIONS, OR DELETIONS TO THE WHIRLPOOL SYSTEM, PUMP OR BATH.

WARNING: Whirlpool pump and piping are factory assembled. Relocation of pump or other modifications could adversely affect the performance and safe operation of this whirlpool. Aquatic, shall not be liable under its warranty or otherwise for personal injury or damage caused by any such unauthorized modification.

QUIETNESS OF OPERATION: Aquatic has engineered their whirlpool baths from base to lip to ensure quality, value, functional design, and maximum bathing comfort. However, installation is accountable for as much as 50% of a tub's operating quietness. Please ensure the following:

- The floor structure is adequate to support the installation.
- For quieter operation and heat retention conservation, the walls surrounding the whirlpool may be insulated.
- Insulate the tub surround. Do not allow any insulation to come within 3 feet of the blower and pump. The area around the blower and pump must be clean and free of any foreign matter.
- Leave 1/8" to 3/16" gap between tub lip and surround.

INSTALLATION INSTRUCTIONS

STRUCTURAL PREPARATION

Note: The bath should remain in its shipping carton until time of installation.

- Literature dimensions are for reference only. Installation dimensions should be taken directly from the tub. An access panel of 30" w x 20" h minimum must be provided at the pump end of the whirlpool allowing sufficient clearance to make final connections and for servicing the pump, blower, heater and control units. A minimum ventilation opening of 2" x 4" for the blower is required and should be designed to draw in ambient air at a minimum of 72°F. Access may be through the wall or platform apron at the end of the unit. In the case of sunken installations, access should be made through the ceiling below.

IT IS THE INSTALLER'S RESPONSIBILITY TO PROVIDE SUFFICIENT SERVICE ACCESS.

MAKE ABSOLUTELY CERTAIN THAT ACCESS PANELS AND/OR SERVICE OPENINGS ARE PROPERLY PLACED AND THAT ALL POSSIBLE AREAS WHERE SERVICE MAY BE REQUIRED ARE ACCESSIBLE.

- Install the drain fitting to the bath. Clearance may be needed for the drain by cutting away the subfloor (where possible) or by blocking below the tub as may be required.
WARNING: FACTORY SKIRTS DO NOT ALLOW FOR BLOCKING UP OF THE TUB BASE. All blocking must be solid and provide uniform support to the tub base.
PLEASE NOTE: LuxeAir versions with the black ABS support bases need to be set in a bed of mortar. This will help in leveling the tub on uneven floors and will help in reducing vibrations and noise.
- Tub must rest entirely on all leveling feet or ABS Support Base. **DO NOT SUPPORT THE WEIGHT OF THE TUB BY THE RIM.** Lift unit and place into framework. Secure the unit by fastening the bottom feet to the sub floor with any construction adhesive caulk. For quieter operation and heat conservation, the walls surrounding the whirlpool may be insulated.
- Frame out under the tub rim as shown in one of the illustrations below. **NOTE:** Due to the variety of installations possible, framing procedures other than those described may be required. Plumb in selected location using a level. Level front to back and across both sides. A ledge under the rim, or an apron without a ledge, may be constructed as required (see Figures 1A, 1B and 1C). Where installation will be against a wall, stud wall framing should allow for wall sheathing material to run full length to the floor (see Figure 1D). Install tub firmly against sheathing as indicated, with blocking below rim to prevent deflection or movement of tub. To prevent a rocking movement of tub after installation, it is important to have rim in contact, but not supported by blocking material.

NOTE: Watertight installation of the drain and overflow is the installer's responsibility. Drain and/or overflow leakage is not included in the warranty of this product.

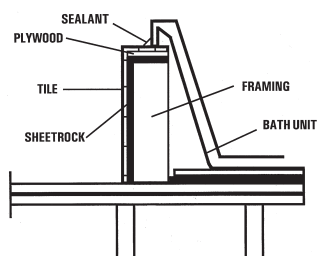

1A Ledge Installation - 1

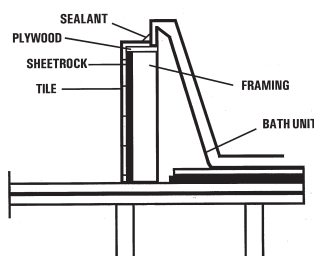

1B Ledge Installation - 2

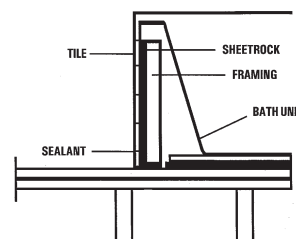

1C Apron Installation

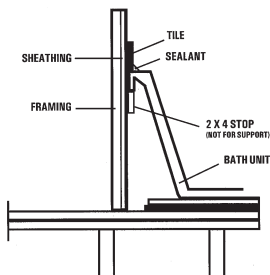

1D Wall Installation

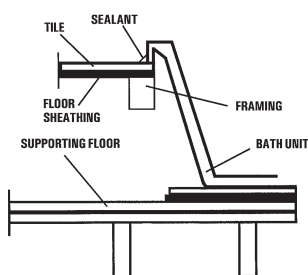

1E Sunken Installation

WARNING: ALL ELECTRICAL CONNECTIONS SHOULD BE MADE BY A LOCALLY LICENSED ELECTRICIAN.

INSTALLATION INSTRUCTIONS

STRUCTURAL PREPARATION (CONTINUED)

5. When placing the tub on a platform or cut out, the opening should be 1" smaller than the specified rim dimensions. Extreme care must be taken in this type of installation to ensure the tub will come to rest entirely on the leveling feet or ABS Support Base.
6. IF YOU HAVE PURCHASED A WHIRLPOOL WITH AN INSTALLED TILE FLANGE, PROCEED TO INSTRUCTION "2A".

FACTORY INSTALLED TILE FLANGE

SEE FIGURE 2

- A. Install the whirlpool bath unit per the instructions provided in this manual.
CAUTION: THE TILE FLANGE DOES NOT SUPPORT THE TUB! A ledger board must be provided under the bath rim as indicated in the installation instructions. Take care to ensure tub is not hanging from the ledger boards, as this will void your warranty.
- B. Use nails or screws to secure the flange into the studs around the bath.
- C. Install water resistant drywall against the tile flange and flush to the top of the whirlpool deck. Install the tile or other finishing materials. Apply a second bead of silicone between the first course of tile and the bath deck.

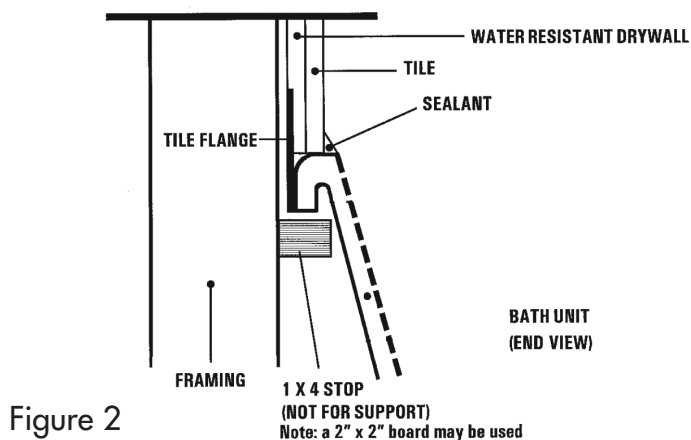

Figure 2

NOTE: Before tub is used, the whirlpool system should be cleaned in accordance with the procedures on Page 21 of this manual.

LUXEAIR 31 & 32 - INTEGRALLY SKIRTED BATHS

ALCOVE FRAMING AND PRE-INSTALLATION PROCEDURES:

1. Protect interior of tub throughout installation procedures.
2. Before moving unit into alcove see and follow enclosed Electrical Installation Procedures (electrical hookups will be difficult to perform if unit is installed first.)

IMPORTANT! BEFORE INSTALLATION BEGINS, MAKE SURE THAT:

1. Framed-in alcove is of proper size, square and plumb.
2. Walls and floors meet fire safety requirements of local building code and/or FHA/HUD Minimum Property Standards. Before installation of the panel, fill the unit, test the whirlpool system for proper operation and check for leaks, then drain.
3. A mortar base is prepared (this is mandatory for proper installation).

INSTALLATION INSTRUCTIONS

INSTALLATION PROCEDURES FOR INTEGRALLY SKIRTED MODELS

1. To avoid obstructions during installation, make sure water lines, spout pipes and valve plumbing do not project into alcove.
2. **Ledger Strip:** Fasten a 1" x 3" (25mm x 75 mm) ledger strip along rear for alcove and along both sides in corner installations at Dimension LH. (see Figure 3A)
3. Place three or four mounds of mortar away from drain hole in a line or square, approximately twice as high as the cavity under the tub bottom.
4. Place tub into alcove with front skirt firmly on floor and depress mortar mounds. Make certain that back ledge of tub rests firmly on ledger strip. (see Figure 3A)
5. See and follow **Sealing & Finishing** Figure 3B.

3A

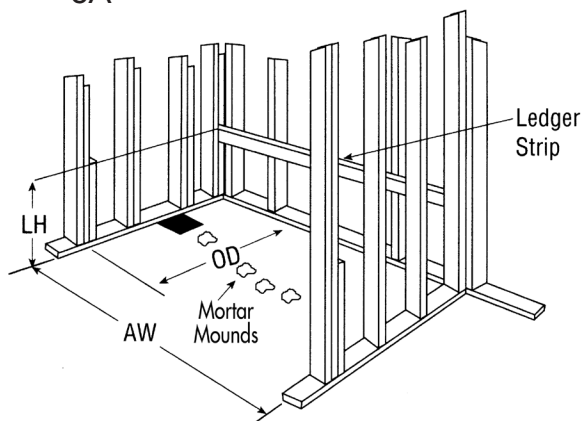

3B

Sealing & Finishing Typical methods of sealing and finishing

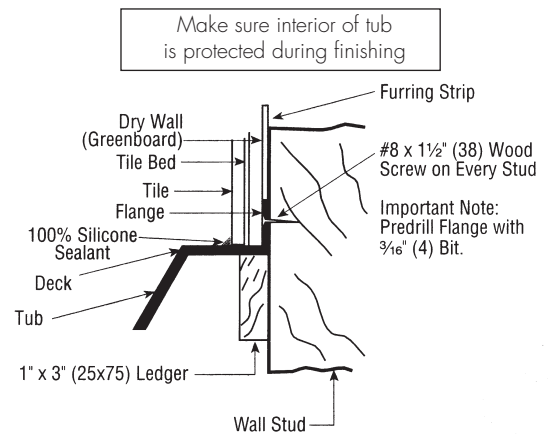

REMOVABLE SKIRT PANELS FOR INTEGRALLY SKIRTED MODELS

These models are offered with removable panels. It provides a flush-to-wall installation (sheet rock overlaps skirt while still providing access). The skirt features a decorative removable panel enabling easy access to motor, pump, blower and electrical hookups. Clips enable simple and quick removal of skirt access panel.

Important: Before installation of the panel, fill the unit, test the whirlpool system for proper operation and check for leaks, then drain.

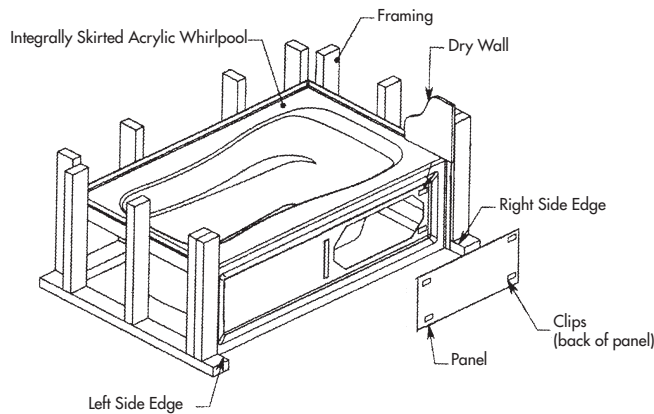

Figure 4

Aquatic



INSTALLATION INSTRUCTIONS

PLUMBING

1. After securing tub in place, normal waste and overflow and valves are installed per normal plumbing procedures, in accordance with all state and local standards.
2. Install standard 1-1/2" trap to drain and overflow. Before proceeding, make a final operational check by filling tub with water to overflow and operate pump for 5 minutes. Check for leaks carefully both while pump is running and has been turned off. Allow water to stand in tub for at least 30 minutes before draining. **Aquatic WILL NOT BE RESPONSIBLE FOR WATER DAMAGE OF ANY KIND IN CONNECTION WITH ONE OF OUR WHIRLPOOL BATHS.**

ROUGH-IN MEASUREMENTS

MODEL	A (From center of overflow pipe to outside rim)	B (From center of drain to tub rim)
LuxeAir 21	6 1/2"	13 1/4"
LuxeAir 22	2 1/4"	12"
LuxeAir 23	5 3/8"	12"
LuxeAir 24	6 3/4"	14"
LuxeAir 25	5 1/4"	16 1/4"
LuxeAir 26	6 1/2"	13 1/2"
LuxeAir 27	2 1/4"	11 1/4"
LuxeAir 28	2 1/4"	11 1/4"
LuxeAir 29	2 1/2"	9 3/8"
LuxeAir 30	2 1/4"	10 1/2"
LuxeAir 31	1 3/4"	10 3/4"
LuxeAir 32	1 5/8"	9 1/4"
LuxeAir 33 Motif	3 1/2"	12 1/4"
LuxeAir 34 Motif	5 1/2"	13 1/2"
LuxeAir 35 Motif	3 1/2"	12 1/2"
LuxeAir 36 Motif	5 1/2"	13 1/2"
LuxeAir 37 Motif	6"	14"

Figure 5

PLEASE NOTE: The manufacturer accepts a 1/4" variance. There are variations on each tub and specifications are subject to change as we improve upon our product as required.

The dimensions needed for site preparation and structure building will differ; Aquatic, assumes no responsibility for preparatory work.

INSTALLATION INSTRUCTIONS

ELECTRICAL INSTALLATION

WARNING: ALL ELECTRICAL CONNECTIONS SHOULD BE MADE BY A LICENSED, LOCALLY CERTIFIED ELECTRICIAN, IN ACCORDANCE WITH THE REQUIREMENTS OF THE NATIONAL ELECTRICAL CODES AND PROCEDURES.

WARNING: When using electrical products, precautions should always be followed, including the following:

DANGER: RISK OF ELECTRIC SHOCK!

**GFCIs are not supplied, however we do specify their use.
All known code authorities require GFCIs.**

LuxeAir baths will need to be hard-wired to the outlets provided. See the following directions and Figure on page 12.

Two junction boxes will be mounted to the frame of the whirlpool. One of the two boxes will have one outlet and will be labeled "Blower". Remove the cover and connect a 14/2 with ground Romex wire from a 15 amp 1-pole GFCI breaker (not supplied) in the main circuit breaker panel. Connect the black wire to the hot side of the receptacle, the white wire to the neutral side of the receptacle and the green wire to ground. Replace the cover and plug in the blower. (See Figure on page 12).

The second junction box will have two outlets, one labeled "Main" and the other labeled "Heater". Remove the cover. Run Romex 14/3 with ground from a 15 amp 2-pole GFCI breaker (not supplied) located in the breaker panel. Connect the white wire (neutral) to both neutrals of the two outlets. Connect the red wire (hot) to the hot terminal of the outlet labeled "Main". Connect the black wire (hot) to the hot terminal of the other outlet labeled "Heater". Connect the green wire (ground) to the ground terminal of the outlet. Replace the cover of the junction box. Find the pump cord and plug it into the outlet labeled "Heater". Plug the cord labeled "Main AC Input" into the outlet labeled "Main" (See Figure on page 12).

CAUTION: Before use of the pump and heater, test the GFCI for proper operation. The pump and heater should turn off when the GFCI "Test" button is pushed.

INSTALLATION INSTRUCTIONS

ELECTRICAL INSTALLATION (CONTINUED)

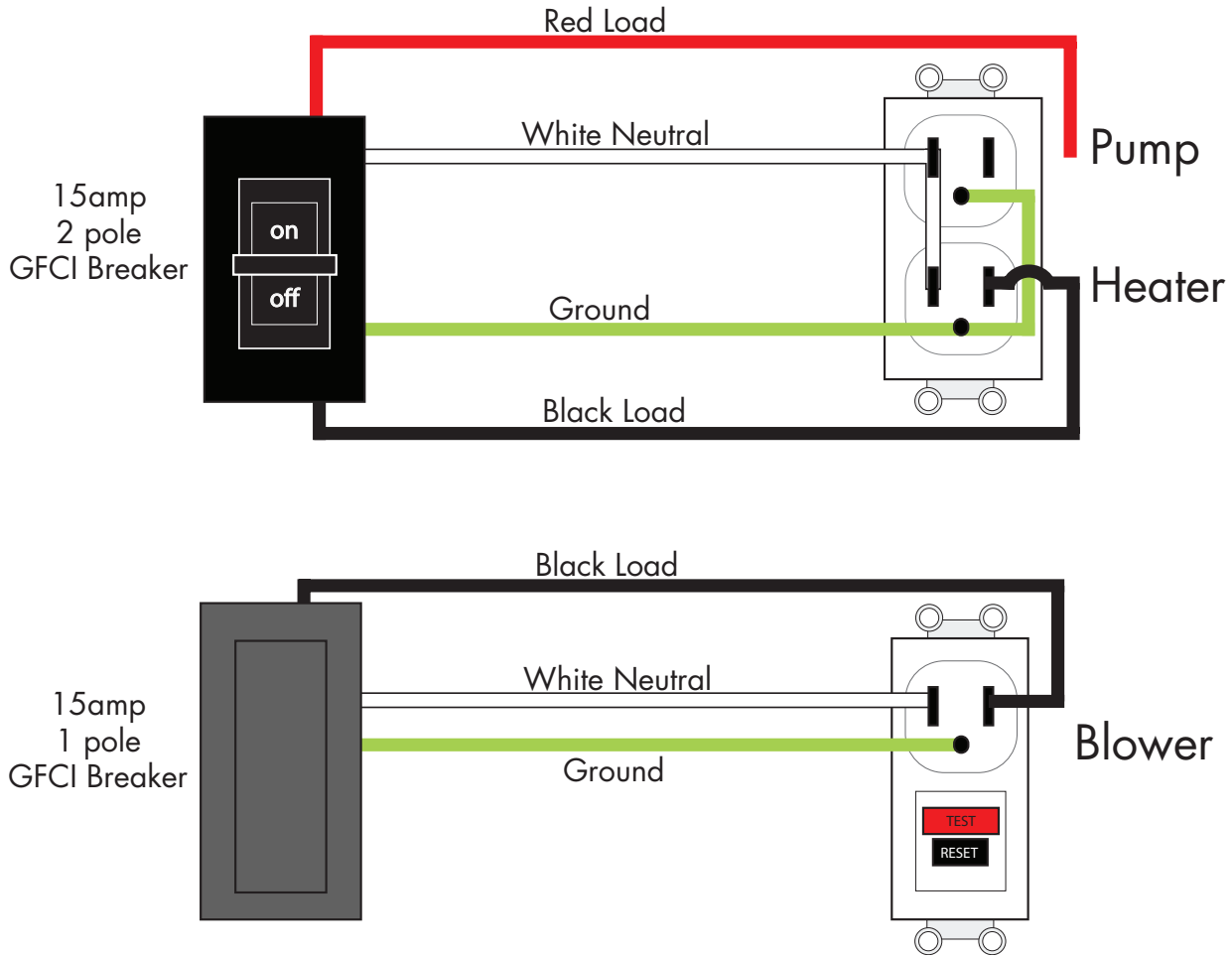

Figure 6

BONDING WIRE: Connect a #8 bare copper bonding wire from the pump motor to the heater and then to the cold water plumbing or other suitable ground. Grounding is required. Grounding is NOT required for the blower.

LuxeAir Series component breakdown *No Chromotherapy*

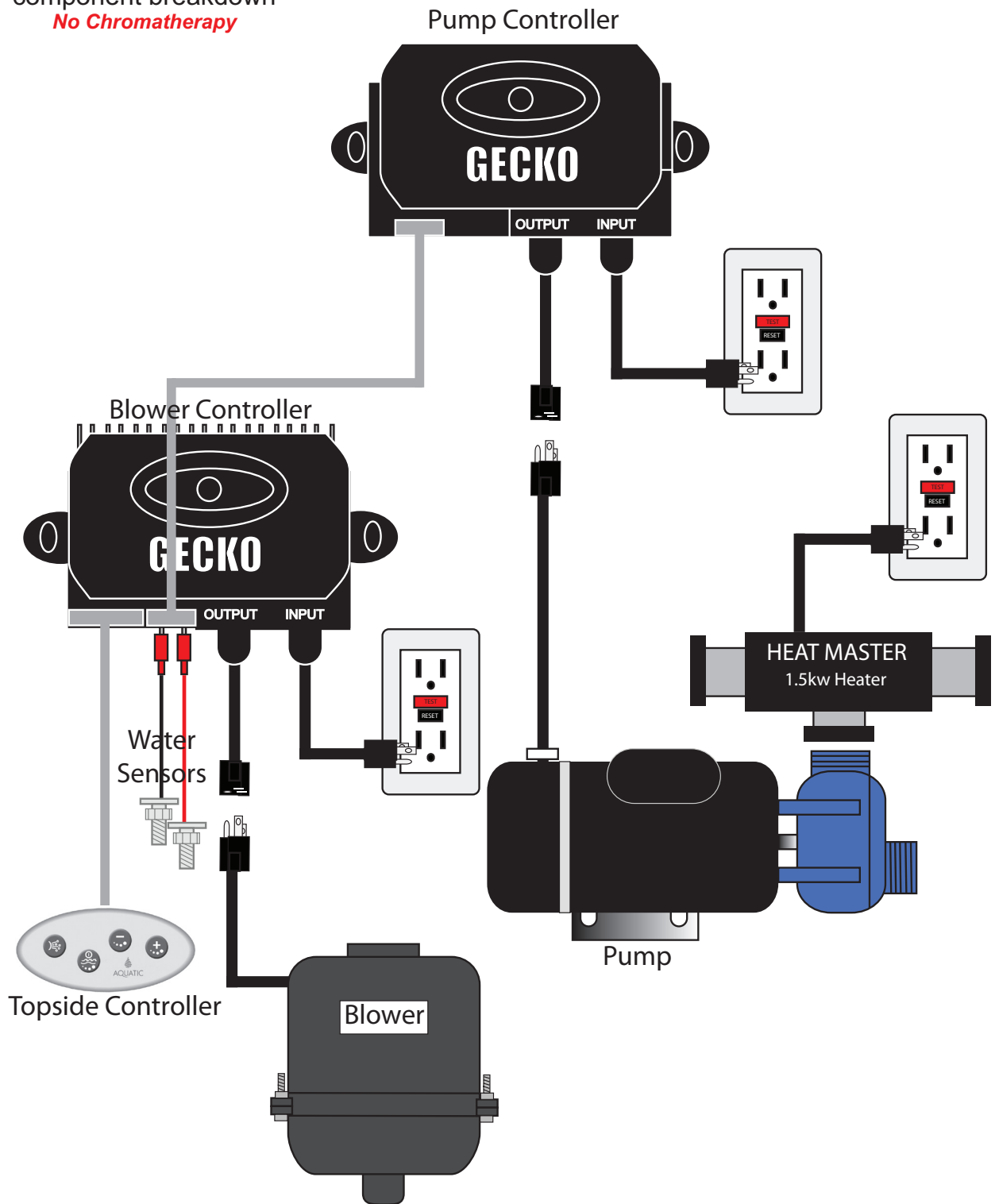

Figure 7

LuxeAir Series component breakdown *With Chromotherapy*

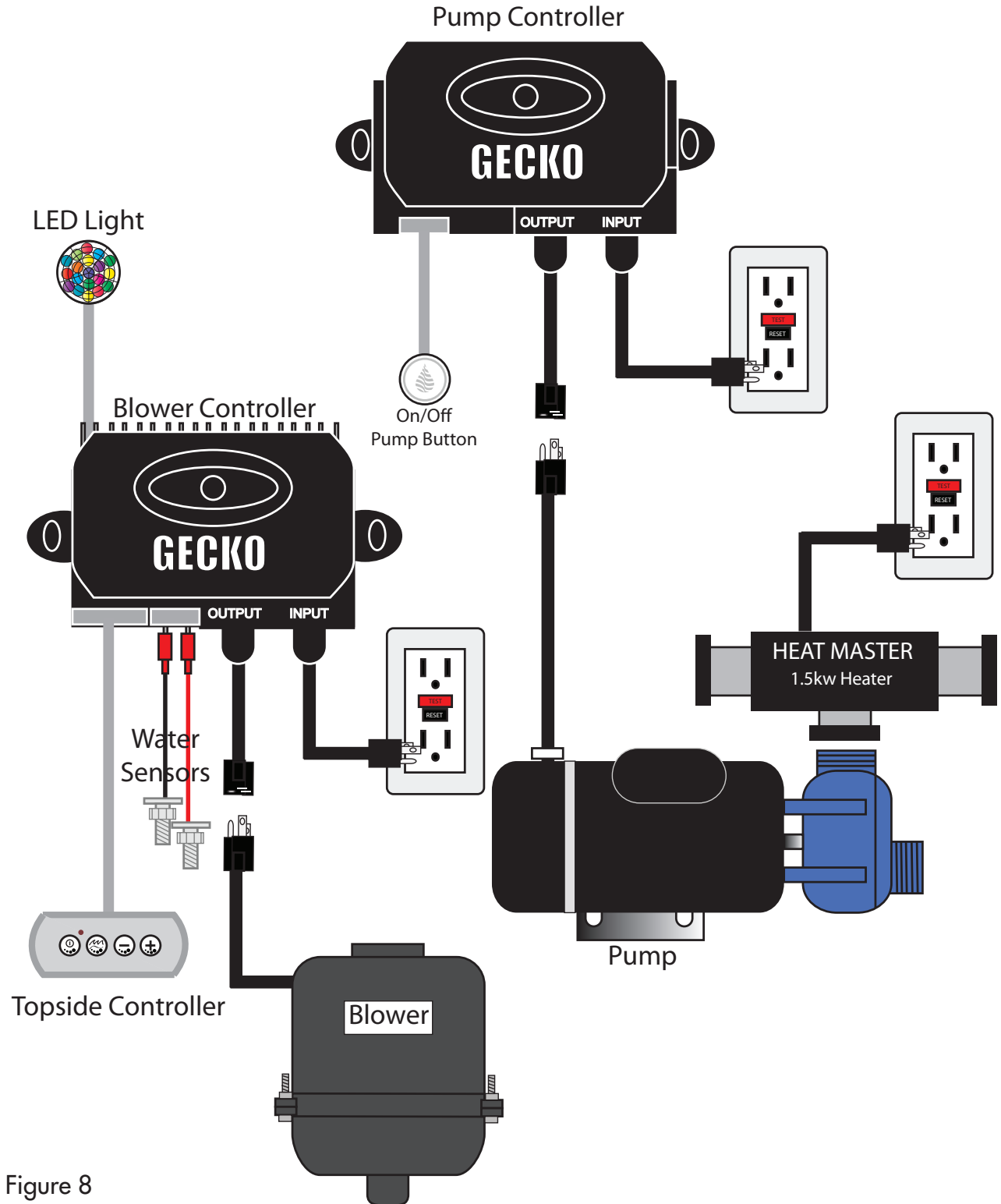

Figure 8

OPERATION

NOTE: DO NOT START PUMP UNTIL ALL JETS ARE SUBMERGED. WATER LEVEL SHOULD BE 2" ABOVE HIGHEST JET.

JET OPERATIONS

All LuxeAir Series jets are removable, and can simply be put into the dishwasher for easy cleaning. (Note: use top rack and remove before drying cycle.)

LuxeAir Series Whirlpool Jets

The LuxeAir Series combines Full-Size Pressure-Flo Hydrotherapy Jets, Aquatic Rotary Massage Jets and StressEaz Neck and Shoulder Massage Jets (most models) to provide an invigorating hydrotherapy experience.

Full Size Pressure-Flo Hydrotherapy Jet:

Designed to facilitate targeted, deep tissue massage therapy. Each Full Size Pressure-Flo Hydrotherapy jet is fully adjustable for direction of water flow and intensity of pressure.

StressEaz Neck and Shoulder Massage Jet:

Aquatic StressEaz Jets feature two side-by-side oval ports through which water moves simultaneously in opposite directions to create a constant circular motion. This unique design effectively creates a consistent, even massage for the user's neck and shoulder areas.

- **To adjust pressure:**
 1. Grasp the outer ring of the jet.
 2. Turn the outer ring clockwise to increase flow, counter-clockwise to reduce flow.
- **To remove jet (see Figures 9A and 9B):**
 1. Grasp the outer ring of the jet.
 2. Turn the jet counter-clockwise, until the jet clicks, then pull.
- **To replace jet (see Figures 9A and 9B):**
 1. Insert the jet into jet housing.
 2. Turn the jet clockwise, past point of resistance, until the jet clicks.

Figure 9A



Figure 9B



OPERATION

INLINE MAINTENANCE HEATER OPERATING INSTRUCTIONS

Operation of the inline maintenance heater is completely automatic. The heater will help maintain the temperature of the water in the whirlpool. The heater includes the following components.

THERMOSTAT: The "Smart Thermostat" requires no adjustment and will automatically maintain the water temperature at 102° F - 104° F. If the whirlpool is too warm, simply adjust by adding cold water.

HIGH LIMIT: The heater includes an exclusive "Intelligent High-Limit". This safety circuit will not "false trip" from hot tap water. It will only turn the heater off if the thermostat fails. To reset, simply press the red button. If the high-limit trips frequently, contact Aquatic,

INDICATOR LIGHT: The light turns on when the heater is operating.

PRESSURE/VACUUM SWITCH: The heater is equipped with a preset pressure or vacuum switch. The pump must be running with water flowing to the whirlpool to allow the heater to turn on.

WARNING - Prolonged Immersions in Hotter Water May Induce Hyperthermia.

Hyperthermia occurs when the internal temperature of the body reaches a level several degrees above the normal body temperature of 98.6° F. The symptoms of hyperthermia include an increase in the internal temperature of the body, dizziness, lethargy, drowsiness, and fainting. The effects of hyperthermia include (1) failure to perceive heat, (2) failure to recognize the need to exit the whirlpool, (3) unawareness of impending hazard, (4) fetal damage in pregnant women, (5) physical inability to exit the whirlpool, (6) unconsciousness resulting in the danger of drowning.

WARNING - The use of alcohol, drugs, or medication can greatly increase the risk of fatal hyperthermia.

OPERATION

BATHSIDE CONTROL SYSTEMS

 **To Turn Blower (Air System) On:** Press once to turn the blower (air system) on. A second press will turn the blower off. Holding the button down for 2 seconds will change modes when the blower is on. There is a 20 minute timer that will automatically turn the blower off.

 Press once to turn the pump (jets) on. A second press will turn the pump off. There is a 20 minute timer that will automatically turn the pump off.

 **To Change Modes:** Holding this button down for 2 seconds will change modes when the blower is on. There is a 20 minute timer that will automatically turn the blower off.

- **Constant Mode:** Consists of a constant blower speed.
- **Wave Mode:** Consists of a gradual change of blower speed to generate a gentle massage effect.
- **Pulse Mode:** Consists of an instant change of the blower speed to generate a massage effect.

 **To Change Speeds:** Pressing this button will increase the blower speed. Holding down this button will continue to increase the blower speed until the maximum speed is obtained.

 Pressing this button will decrease the blower speed. Holding down this button will continue to decrease the blower speed until the minimum speed is obtained. The blower's heater will only be fully on at maximum speed. As you decrease the speed of the blower, the heater's output will decrease.

CAUTION: Due to varied size, weight and shape of a person's body, water may splash out of the tub when the air blower is on high speed. Turn the speed of the blower down using the minus button  to a lower setting to reduce the amount of water being dispersed from the tub.

Air Bath Purge Cycle:

Twenty minutes after the pump or blower is turned off, either manually or by the timer, the blower will turn on at full power for 3 minutes to purge the air channels of water. During this 20 minute waiting period, depressing the on/off button will cancel the purge cycle and starts another massage cycle.

During the 3 minute purge cycle, depressing the on/off button will cancel the remaining purge cycle.

Automated dry Cycle:

Regardless if the air bath system was utilized, an automated dry cycle will turn on 20 minutes after the water sensors do not detect water. The automated dry cycle will turn on for 3 minutes (once the sensors are dry) to purge the air channels after any contact with water, including after a shower or cleaning/rinsing of the bath. The two water sensors are located near the drain.

Purge 24 Hours:

24 hour purge: The blower automatically comes on to purge the air channels of water. This will happen every 24 hours from the time the 24 hour purge was activated.

Activating the 24 hour purge: Holding down the on/off pump button for 5 seconds when the blower is off will activate the 24 hour purge cycle. The blower will then come on to purge the air channels every 24 hours from the time it was set.

This will be confirmed by the blower coming on for 1 second, turning off for 2 seconds and then coming back on for 1 second.

Cancelling the 24 hour purge cycle (not recommended): Holding down the on/off pump button for 5 seconds when the blower is off will cancel the 24 hour purge cycle.

This will be confirmed by the blower coming on for 1 second and then turning off.









Figure 10

OPERATION

BATHSIDE CONTROL SYSTEMS W/ OPTIONAL CHROMATHERAPY

Electronic Control Panel:

(see Figure 11):

- To Turn Air Bath System On:** Pressing the "On/Off"  button will turn the blower on in "constant mode." The light indicator will illuminate when the system is on. The blower and the heater will automatically shut off after a 20-minute period.
- To Change Modes:** Pressing the mode button alternates the blower modes of operation from constant mode to wave mode and then to pulse mode.
 - **Constant Mode:** Consists of a constant blower level with no change. When the blower is on, the indicator light is on. When the blower is off, the indicator light is off.
 - **Wave Mode:** Consists of a gradual change of blower level to generate a gentle massage effect. The light indicator will also follow the blower intensity.
 - **Pulse Mode:** Consists of an instant change of the blower level to generate a massage effect. The light indicator will also pulse as the blower does.
- To Change Speeds:** In constant mode, pressing and holding the "+"  button will increase the variable speed of the blower to the maximum. Pressing and holding the "-"  button will reduce the blower's variable speed to the minimum. In both cases, the user can release the button at the desired power level. Note: In wave mode or pulse mode, the "+"  or "-"  buttons will work the same way but will have an effect on the maximum power of the wave and pulse mode.
- To Turn Chromatherapy Light On:** Press the light  button once to turn the Chromatherapy Light on in color wash mode. A second press of the button will turn the lighting system off. Subsequent presses will move the lighting system through the seven constant color modes.

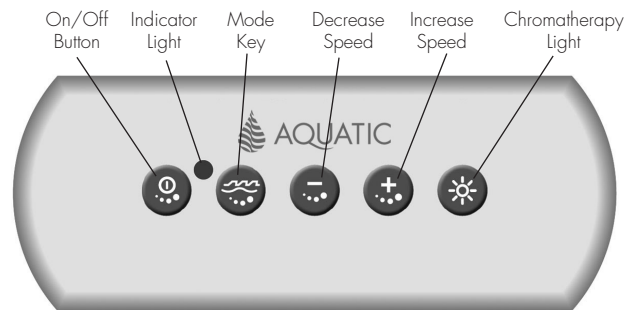





Figure 11

CAUTION: Due to the varied size, weight and shape of a person's body, water may splash out of the tub when the air blower is on high speed. Turn the speed of the blower down using the "-"  button to a lower setting to reduce the amount of water being dispersed from the tub.

Air Bath Purge Cycle:

Following the 20 minute run time of the blower, there will be a 15 minute idle period. The blower will then turn on for 3 minutes for the purge cycle. If the user turns the blower off manually before the timer reaches 20 minutes, the idle period will start after the blower has been turned off. During the 15 minute idle period and the 3 minutes purge, the light indicator of the On/Off  button will blink. During the idle period, pressing the On/Off  button will turn on the blower in constant mode. During the 3 minute purge, pressing the blower key will stop the purge.

Automated Dry Cycle:



Regardless if the air bath system was utilized, an automated dry cycle will turn on 20 minutes after the water sensors do not detect water. The automated dry cycle will turn on for 3 minutes (once the sensors are dry) to purge the air channels after any contact with water, including after a shower or cleaning/rinsing of the bath. The two water sensors are located near the drain.

OPERATION



BATHSIDE CONTROL SYSTEMS W/ OPTIONAL CHROMATHERAPY (CONT.)

Purge 24 Hours:

It is possible for the user to program a purge cycle that will start every day for a duration of 1 minute. Aquatic strongly recommends activating this feature. The purge cycle will help ensure that the air channels stay dry even when you have taken a soaking bath or shower.

To activate this purge feature, the user must hold down the "+"  button for 5 seconds when the blower/heater is off or waiting for the normal purge. Then, the light indicator on the On/Off  button will blink twice. If the unit was in standby for a normal purge when the 24 hour purge was activated, the normal purge will be cancelled.

To show the user that the 24 hour purge is activated, the light indicator on the On/Off  button will blink at a slow rate. A different blinking rate was picked in order to make it easier for the user to differentiate it from the standby of the regular purge cycle.

The purge will be done every day at the same time the user activated it (pressed the "+"  button). By pressing the "+"  button again, the 24 hour purge will be deactivated and the light indicator on the on/off button will stop blinking and turn off.

On/Off Control for Jets (Pump):

NOTE: DO NOT START PUMP UNTIL ALL JETS ARE SUBMERGED. WATER LEVEL SHOULD BE 2" ABOVE HIGHEST JET.

The **On/Off Electronic Button with Timer** is the On/Off Button for the pump/jet action for the LuxeAir baths with optional chromatherapy.

1. Make sure whirlpool has enough water in it to submerge the highest jets by about 2 inches of water.
2. Push the On/Off Button once to turn the pump on. The whirlpool has a built-in timer and will automatically turn off in approximately 20 minutes. To restart the pump, simply push the On/Off Button.
3. When the motor is running, push the On/Off Button to turn the pump off.



Electronic On/Off Button

OPERATION

TO REPLACE LED LIGHT:

1. Disconnect the power to your bathtub.
2. Drain the bathtub.
3. Open the lens of the fixture using ONLY the proper tool provided for that purpose. Do not attempt to remove the lens without the provided tool.
4. Replace your LED light (replacement LED lights can be obtained from Aquatic).
5. Verify "O" ring is not damaged and is properly positioned in the groove when replacing the lens. If there is damage or lens does not seal properly, do not refill bathtub.

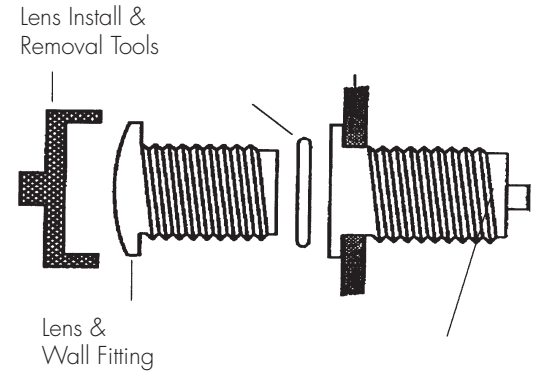

NOTE: Do not twist LED light into socket. Use gentle pressure and push LED light into place.

CARE AND MAINTENANCE

INITIAL CLEANING

Before tub is used, the whirlpool system should be cleaned and disinfected. Remove all debris and clean tub before putting whirlpool into service. **DO NOT USE ABRASIVE CLEANERS ON THE ACRYLIC FINISH.** Use a non-abrasive detergent and rinse well after cleaning.

- Fill the tub with HOT water to a level 2" above the highest jet.
- Add 2 teaspoons of low-sudsing automatic dishwashing detergent and no more than 4 ounces of household bleach to the water.
- Operate whirlpool for 10 minutes. Drain. **Note:** To effectively clean both the whirlpool and air bath system, you must operate them both.
- Refill with cold water and operate whirlpool for 5 minutes. Drain.

WHIRLPOOL SYSTEM CLEANING

To remove accumulations of bath residue from the whirlpool system, we recommend that you purge it at least twice a month, or more depending on usage. To do this, follow this simple procedure. Fill the bath with hot water (not exceeding 140° F). Add to the hot water, 4 (6) tablespoons of low foaming detergent such as liquid Cascade or Calgonite and 24 (48) oz. of liquid household bleach, such as Clorox [use lesser amounts shown for 5-foot bathtubs, greater amounts in parentheses for larger bathtubs]. Run the bath for 5 to 10 minutes. Drain the bath completely and refill with cold water only. Run the whirlpool for 5 to 10 minutes, then drain the bath completely. Depending on the usage and/or the content of the local water supply, more frequent purging may be necessary.

AIR BATH SYSTEM CLEANING

NOTE: DO NOT TURN THE PUMP ON DURING THE AIR BATH CLEANING.

Before tub is used, your air bath and plumbing system should be flushed. Close the drain. Fill bath with hot water to at least six inches above air injector holes. Add 2 teaspoons of low sudsing automatic dishwashing detergent and no more than 4 ounces of bleach to the water. **DO NOT** use bleach or other chlorinated cleansers on metal trim surrounding control panels. Turn blower on for approximately two minutes to mix cleaner with water. Shut blower down and allow cleaner to soak in the bath for approximately two hours. Turn ON air bath and run for approximately five minutes. Turn air bath unit OFF and drain tub. Aquatic recommends the above cleaning process on your air bath system once a month.

NOTE: DO NOT USE OIL OR OIL BASED BATH ADDITIVES.

If you want to use any kind of bath additive, use only a small amount of low-foaming powder or crystal substance; the whirlpool action intensifies the foaming properties of soaps. The use of certain bubble baths and bath additives may increase the level of accumulations of bath residue in the whirlpool system. If excess accumulations persist, you should discontinue use of these products.

If you have followed the monthly purging instructions and still have an excess accumulation of bath residue and desire an alternative cleaning mechanism, we recommend **SUPER SYSTEMS CLEAN PLUS** manufactured by Stearns Packaging Corporation to rectify this condition. This may be obtained by calling Aquatic, at (800) 945-2726. It is recommended that you follow the instructions provided by the manufacturer with the product. Repeated use may be necessary. **SUPER SYSTEMS CLEAN PLUS** does not replace the necessity to purge your whirlpool system at least twice a month with a low foaming detergent and bleach.

SURFACE CLEANING

Use common household, non-abrasive cleaners for most cleaning jobs. Rinse well and dry with a clean cloth. Never use abrasive cleaners. Do not allow your Lucite® acrylic surface to come into contact with products such as acetone (nail polish remover), nail polish, dry cleaning solution, lacquer thinners, gasoline, pine oil, etc. Remove dust with a soft, dry cloth. Clean grease, oil, paint, and ink stains with isopropyl (rubbing) alcohol.

CARE AND MAINTENANCE

JET CLEANING

All LuxeAir Series jets are removable, and can simply be put into the dishwasher for easy cleaning. See Jet Operation Instructions for removal, page 15. (Note: Use top rack of dishwasher and remove before the drying cycle starts.)

SURFACE SCRATCH REMOVAL

Minor scratches may be removed by polishing your tub with a non-abrasive car polish, followed by buffing. Deeper scratches can be removed by:

- Sanding with wet 400 grit sandpaper.
- Sanding with wet 600 grit sandpaper.
- Sanding with wet micro-grit sandpaper.
- Buff out using car polish.

REPAIR

The installation and service of your whirlpool bath should be performed only by a qualified service technician. Remember when contacting your dealer always have your serial number, proof of purchase and model number available. This will ensure a quick response on warranty items.

The model and serial numbers are located above the pump on the backside of the whirlpool.

NOTE: ALL WARRANTY REPAIRS MUST BE AUTHORIZED BY AQUATIC BEFORE WORK IS STARTED. FOR SERVICE, ALWAYS CONTACT YOUR DEALER.

CAUTION: Care should be taken to prevent inappropriate chemicals coming in contact with the Lucite® acrylic surface. Please read and observe all instructions and/or warnings on containers containing substances you contemplate applying to your whirlpool. Any failure to comply may void your warranty.

WATER QUALITY ISSUES

Owners of fill and drain whirlpool bathtubs need to know basic information concerning water quality: how it affects performance and enjoyment of the operation of their tubs, and steps that can be taken by the owner to correct related problems. Important issues are the microbiological and chemical quality of the water.

1. Microbiological Quality

Microbes are present in water supplied by individual wells or water systems and even in the air around us. These microbes are usually in amounts below what is noticeable. Microbes from the water or air or from a bathers body may settle on wetted surfaces such as a whirlpool bathtub's surface or piping systems where they can grow in numbers where we can notice them. With regards to whirlpool bathtubs, brown/black fungi/mold or pigmented (colored) bacteria can be noted.

Fungi/Mold- Fungi and mold are always present. The levels are usually such that we do not notice them. When moisture and temperature are sufficient, the organisms will grow to levels that we may smell and/or see. The best example of such growth is the very common black growth on the bottom of shower curtains. The best solution to keep these surfaces free from growth is frequent cleaning.

CARE AND MAINTENANCE

WATER QUALITY ISSUES (CONTINUED)

Pigmented Bacteria- Water utilities from all over the United States have experienced calls from consumers inquiring and complaining about pinkish substance on bathroom fixtures that is very persistent, appearing in the shower, sink and along the water line of toilet bowls. With whirlpool bathtubs, the formation of this colored substance may be particularly pronounced in white tubs. The residue is less likely a problem associated with water quality than with naturally occurring airborne bacteria. The bacteria may produce a pinkish film, and sometimes a dark gray film, on surfaces that are regularly moist, including toilet bowls, shower heads, sink drains and tiles. The problem is more common in humid areas of the country. In any particular case, the determination of the exact species of bacteria causing the problem would require lengthy and costly laboratory testing; however, most experts believe the bacteria responsible is *Serratia marcescens*. These bacteria thrive on moisture, dust and phosphates, and are widely distributed in soil, food and also in animals. The American Water Works Association suggests that short of buying pink fixtures, the best solution to keep these surfaces free from the bacterial film is continual cleaning. The AWWA recommends a chlorine containing compound as the best cleaner and avoiding abrasives to avoid scratching fixtures, which will make them more susceptible to bacteria.

2. Chemical Quality

The water supplied by individual wells or water systems always contains chemicals, usually in amounts below those which the consumer would notice. Examples of such chemicals, which are of potential concern for the owners of fill and drain whirlpool bathtubs, are calcium and magnesium salts, copper, iron, manganese and sulfates. When these chemicals are present in sufficient amounts, they may cause problems in whirlpool bathtubs. You should contact your water supply or treatment company and follow their suggestions for treatment.

Calcium and Magnesium Salts- Collectively, the various compounds of calcium and/or magnesium are referred to as salts. Calcium and magnesium salts are often found in ground water supplies and cause "hardness" in water. Hard and soft water are relative terms. Hard water retards the cleaning action of soaps and detergents, causing expense in the form of extra work and cleaning agents. When hard water is heated, it will deposit a hard scale. With regard to whirlpool bathtubs, high calcium and/or magnesium levels may result in the formation of white stains and scale formation on the inside of the tubs, especially noticeable with colored tubs. If this occurs, you need to contact the water supplier to determine the calcium and/or magnesium content and/or corrosion potential of the water and follow their suggestions for treatment. If you are on an individual well, you need to contact a water treatment company to test your water and suggest solutions if a problem is present.

Iron- Iron is found in many natural waters especially from wells. Iron in water can also result from the corrosion of piping in the water supply system, such as cast iron mains or galvanized steel service lines, or galvanized piping in the home water system. High iron levels may result in the formation of brown stains in the vicinity of the faucet outlets of various fixtures in the home. With whirlpool bathtubs, the staining may be particularly pronounced because the aeration action can oxidize iron to a form that settles out on the inside of the tubs, especially noticeable in white tubs. If high iron in the water is present, you can also notice rust colored deposits in your toilet tank or dishwasher. If this occurs, you need to contact the water supplier to determine the iron content and/or corrosion potential of the water and follow their suggestions for treatment. If you are on an individual well, you need to contact a water treatment company to test your water and suggest solutions if a problem is present.

Manganese- Manganese is found in many natural waters, especially from wells. High manganese levels may result in the formation of small black particles that can stain laundry, especially noticeable with whites such as sheets or towels. With whirlpool bathtubs, the formation of small black particles may be particularly pronounced because the aeration action in the tub can oxidize manganese to an insoluble form that is especially noticeable with white tubs. If high manganese in the water is present, you may also notice black stains on white laundry. If this occurs, you need to contact the water supplier to determine the manganese content of the water and follow their suggestions for treatment. If you are on an individual well, you need to contact a water treatment company to test your water and suggest solutions if a problem is present.

CARE AND MAINTENANCE

WATER QUALITY ISSUES (CONTINUED)

3. Treatment

If you have contacted your water supplier and followed its instructions and you are still having problems, you need to increase the frequency of applications of low-foaming detergent/bleach starting from bi-monthly purging down to using it every other day as required to eliminate your particular problem.

The use of certain bath oils, bubble baths and bath additives may increase the level of accumulations of bath residue in the whirlpool system. More frequent cleaning may be necessary if these products are used in the whirlpool tub. If excess accumulations persist, you should discontinue use of these products.

If you have followed the monthly purging instructions and still have an excess accumulation of bath residue and desire an alternative cleaning mechanism, we recommend SUPER SYSTEMS CLEAN PLUS manufactured by Stearns Packaging Corporation to rectify this condition. This may be obtained by contacting Aquatic at (800) 555-5324. It is recommended that you follow the instructions provided by the manufacturer with the product. Repeated use may be necessary. SUPER SYSTEMS CLEAN PLUS does not replace the necessity to purge your whirlpool system at least once a month with a low foaming detergent and bleach.

WHIRLPOOL USER INFORMATION

PLEASE NOTE:

The whirlpool action may cause even small amounts of bubble bath or shampoo to foam excessively. Exercise moderation in experimenting with different soap products.

No servicing of this product should be done by the user. There are no user serviceable parts. All controls are located in the control recesses on the lip of the tub. These are the only controls that should be used by the consumer. Do not change or alter any of these controls under any circumstances.

Motors are self-lubricating - No lubrication required.

FCC CONSUMER INFORMATION

Electrical Installation Information Listed on pages 11 and 12.

This equipment generates and uses radio frequency energy and if not installed and used properly, that is, in strict accordance with the manufacturers instruction, may cause interference to radio and television reception. It has been type tested and found to comply with the limits for a class B computing device in accordance with the specifications in subpart J of part 15 of the FCC rules, which are designed to provide reasonable protection against such interference in a residential installation. However, there is no guarantee that interference will not occur in a particular installation. If this equipment does cause interference, which can be determined by turning the equipment on and off, the user is encouraged to try to correct the interference by one or more of the following measures:

- Reorient the receiving antenna.
- Relocate the receiver with respect to the bath tub.
- Move the receiver away from the bath.
- Plug the receiver into a different outlet so that the receiver and bath are on different branch circuits.
- If necessary, the user should consult the dealer or an experienced radio/television technician for additional suggestions.
- The user may find the following booklet prepared by the Federal Communications Commission helpful: "How To Identify and Resolve Radio-TV Interference Problems."

This booklet is available from the U.S. Government Printing Office, Washington, DC 20402, Stock No. 004-000-00345-4.

TROUBLESHOOTING GUIDE

WARNING: Always turn off power at the main electrical service panel when servicing your whirlpool.

SYMPTOMS	POSSIBLE PROBLEMS	SUGGESTED SOLUTIONS
Motor does not start	<ol style="list-style-type: none"> 1) GFCI or circuit breaker in OFF position. 2) Fuses blown or thermal overload open. 3) Locked motor shaft. 4) Motor windings burned out. 5) Defective starting switch inside single-phase motor. 6) Disconnected or defective wiring. 7) Low voltage. 	<ol style="list-style-type: none"> 1) Reset GFCI. 2) Contact your electrician. 3) Contact Aquatic. 4) Contact Aquatic. 5) Contact Aquatic. 6) Check and reconnect if needed. 7) Contact your electrician.
Motor does not reach full speed	<ol style="list-style-type: none"> 1) Low voltage. 2) Motor windings connected for wrong voltage. 3) Wiring too small. 	<ol style="list-style-type: none"> 1) Contact your electrician. 2) Contact Aquatic. 3) Contact your electrician.
Low pump pressure	<ol style="list-style-type: none"> 1) Pump running at reduced speed. 	<ol style="list-style-type: none"> 1) See above.
Motor overheats (protector trips)	<ol style="list-style-type: none"> 1) Low voltage. 2) Motor windings connected for wrong voltage. 3) Inadequate ventilation. 4) Wiring too small. 	<ol style="list-style-type: none"> 1) Contact your electrician. 2) Contact Aquatic. 3) Refer to installer/dealer. 4) Contact your electrician.
Pump delivers no water	<ol style="list-style-type: none"> 1) Jets are closed. 2) Leakage of air into suction system. 3) Impeller clogged. 	<ol style="list-style-type: none"> 1) Open jets. 2) Check suction screen for clogs. 3) Clean and unplug.
Low pump capacity	<ol style="list-style-type: none"> 1) Suction or discharge line partly plugged. 2) Pump running at reduced speed. 3) Impeller clogged. 	<ol style="list-style-type: none"> 1) Clean and unplug. 2) See "Motor does not reach full speed." 3) Clean and unplug.
Noisy pump and motor	<ol style="list-style-type: none"> 1) Worn motor bearings. 2) Pumps touching a stationary object. 3) Suction line partly plugged. 4) Pump not supported properly. 	<ol style="list-style-type: none"> 1) Contact Aquatic. 2) Refer to installer/dealer. 3) Clean and unplug. 4) Contact Aquatic. (If you have a remote pump, refer to installer/dealer.)
Leakage of water at shaft	<ol style="list-style-type: none"> 1) Shaft seal requires replacement. 	<ol style="list-style-type: none"> 1) Contact Aquatic.
Leaking unions	<ol style="list-style-type: none"> 1) O-ring missing or damaged. 2) Plumbing in a bind. 3) Loose unions. 	<ol style="list-style-type: none"> 1) Contact Aquatic. 2) Contact Aquatic. 3) Tighten unions.
Vibration noise	<ol style="list-style-type: none"> 1) Tub or tub plumbing is touching tile/wall. 2) Pump is touching framing. 	<ol style="list-style-type: none"> 1) Refer to installer/dealer. 2) Refer to installer/dealer.
Air Bath system does not operate	<ol style="list-style-type: none"> 1) No power to air blower. 2) Blower Control Box is not plugged in. 3) Control Panel connector to controller box is disconnected. 4) Blower Motor is disconnected from control box. 	<ol style="list-style-type: none"> 1) Reset circuit breakers and GFCI if tripped. Check fuses and replace if bad. 2) Make sure plug is fully inserted into the outlet. 3) Check and reconnect if needed. 4) Plug Blower into control box.
Blower turns off by itself or before time elapses	<ol style="list-style-type: none"> 1) Blower motor overheated and thermal protection device deactivated motor (possibly low voltage). 2) GFCI tripped. 	<ol style="list-style-type: none"> 1) Check that blower has sufficient ventilation, and that the intake to the blower is not blocked, clear and allow motor to cool down. (Check service & wire size.) 2) Refer to installer/dealer.
Circuit breaker trips repeatedly	<ol style="list-style-type: none"> 1) Defective breaker. 2) Short circuit between bath and breaker box. 3) Other times are connected to the same circuit. 	<ol style="list-style-type: none"> 1) Change out breaker. 2) Refer to installer/dealer. 3) Refer to installer/dealer.
Blower does not manually shut off	<ol style="list-style-type: none"> 1) Defective control panel. 2) Defective control box. 	<ol style="list-style-type: none"> 1) Refer to installer/dealer. Replace control panel. 2) Refer to installer/dealer. Replace control box.
Air blower does not function properly while in the pulse or wave modes	<ol style="list-style-type: none"> 1) Speed of air setting is set too low. 	<ol style="list-style-type: none"> 1) Change the air speed setting to a mid-range setting before switching to wave or pulse modes.



REPLACEMENT PARTS ORDER FORM FOR LUXEAIR SERIES

How To Use:

1. Find your part on the map and make note of its number & letter.
2. Using map number and letter, choose part number and select color (or finish) on Parts List provided on pages 28-29.
3. Fill out the form below with the selected information. Fax or send to Aquatic.
4. Call Aquatic for parts pricing and shipping charges.

IMPORTANT!

The following information **MUST** accompany your order:

Serial Number, Model Number/Name, Purchase Date and Color

PLEASE FILL OUT COMPLETELY:

SHIP TO:

Name _____

Company _____

Address _____

City _____ State _____ Zip _____

Phone _____ Fax _____

BILL TO:

Name _____

Company _____

Address _____

City _____ State _____ Zip _____

Phone _____ Fax _____

Serial # _____ Model Name _____

Model # _____ Color _____ Purchase Date _____

Quantity	Part No.	Description	Color/Finish	Price
_____	_____	_____	_____	_____
_____	_____	_____	_____	_____
_____	_____	_____	_____	_____
_____	_____	_____	_____	_____
_____	_____	_____	_____	_____
_____	_____	_____	_____	_____

Mail orders to:

AQUATIC

8101 E. Kaiser Blvd. • Anaheim, CA 92808
(800) 945-2726 • Fax (866) 544-5353

LUXEAIR SERIES REPLACEMENT PARTS MAP

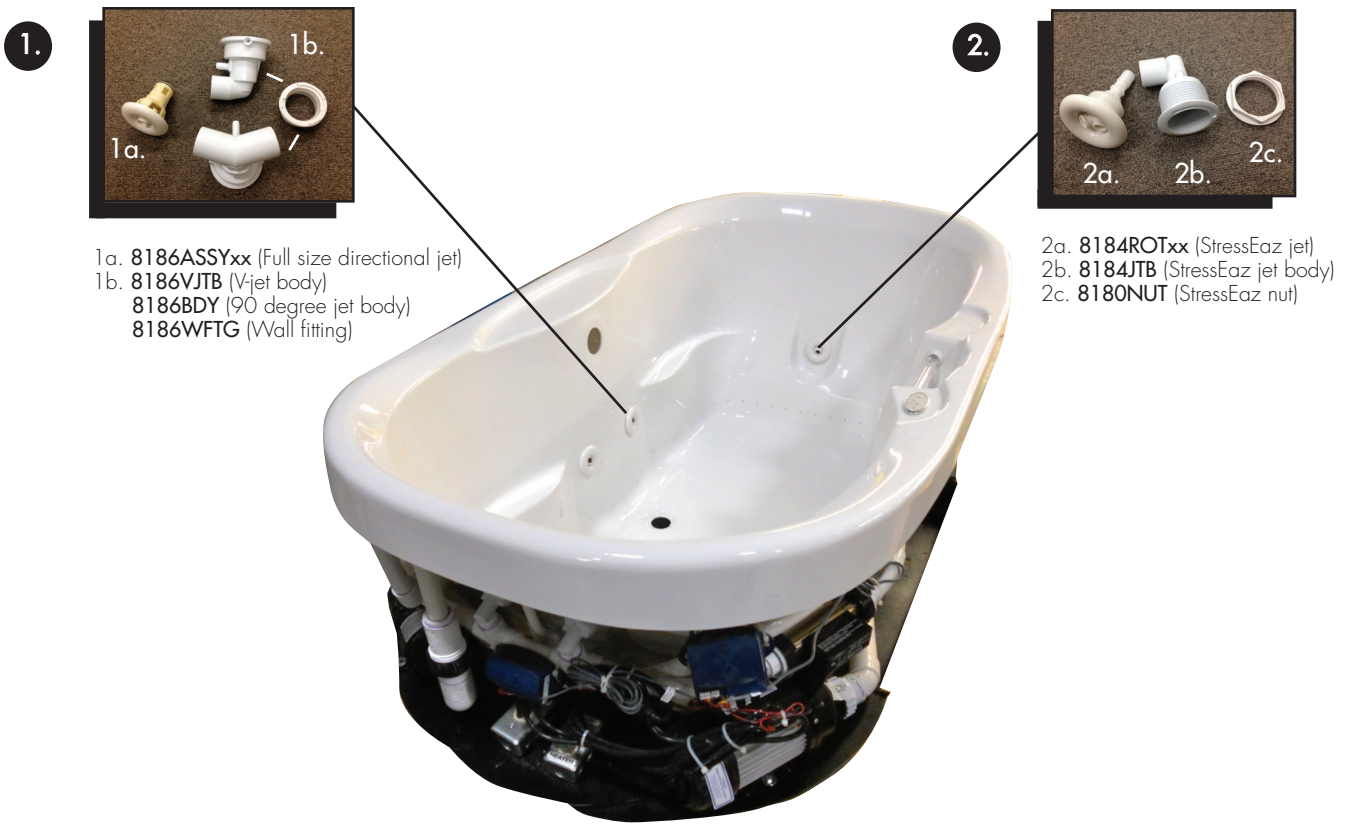

1.

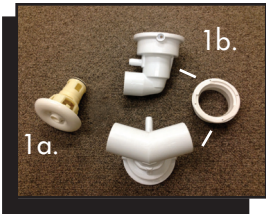

- 1a. 8186ASSYxx (Full size directional jet)
- 1b. 8186VJTB (V-jet body)
- 8186BDY (90 degree jet body)
- 8186WFTG (Wall fitting)

2.

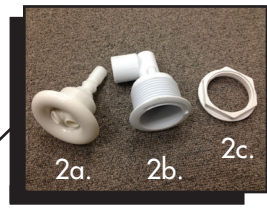

- 2a. 8184ROTxx (StressEaz jet)
- 2b. 8184JTB (StressEaz jet body)
- 2c. 8180NUT (StressEaz nut)

3.



- 3a. 1104PAD (Pump/Blower Control – NO Chromatherapy option)
- 3b. 100667 (Pump control – WITH Chromatherapy option)
- 3c. 1110PADCL (Airbath control – WITH Chromatherapy option)

LUXEAIR SERIES REPLACEMENT PARTS MAP



7a. 1126xx (Suction cover)
7b. Suction wall fitting
7c. Suction elbow



Aquatic Limited Lifetime Warranty

FOR MILLENNIUM, INFINITY AND LUXE AIR SERIES WHIRLPOOLS, SERENITY AIR BATHS, SERENITY STUDIO,
HOTSOAK SERIES BATHS AND RESTORATION SERIES

Limited Warranty For Original Consumer For Household Usage

WHAT PRODUCTS ARE COVERED

Structures and surface finishes, pumps and blowers on the Millennium, Infinity, LuxeAir, Serenity Air Baths, Serenity Studio, HotSoak, and Restoration Series.

Warranty Periods for Specific Components

LIFETIME WARRANTY FOR WHIRLPOOL/AIR BATH/TUB SHELL, PUMP AND BLOWER

Aquatic extends to the original consumer purchaser of the acrylic, fiberglass reinforced shell, a non-transferable lifetime warranty that the shell will retain its structural integrity and configuration and be free of water loss due to a defect in the tub shell. The warranty covers the tub shell and the factory installed pump and blower against defects in material or workmanship. This warranty does not apply to all other components (attachments to the acrylic, fiberglass reinforced shell, such as plumbing, fittings and other apparatus) because these pieces are covered below under a 2 Year Warranty.

LIFETIME SURFACE WARRANTY FOR FACE OF WHIRLPOOL/AIR BATH/TUB

The interior surface is warranted against fading, blistering, cracking and delamination due to defects in the surface materials for life. This surface warranty extends to defects due to surface material mixing or molding. This surface warranty does not apply to fading, cracking, delamination or blistering due to excessive wear, sun fading or scouring due to cleaning.

2 YEAR EQUIPMENT WARRANTY FOR SUPPORT EQUIPMENT, COMPONENTS, CONTROLS & PLUMBING EQUIPMENT

All support equipment; components, controls and plumbing equipment are warranted for 2 years from date of purchase, but not more than 3 years from date of manufacture, against defects in workmanship and materials. Light bulbs, fuses and pillows are not included in this two-year period. However, these accessories are warranted to be free from defects in materials and workmanship at the time of delivery to the original purchaser. Limited labor is covered for 2 years from purchase, but never more than 3 years from date of manufacture, for limited labor on the support equipment, controls, and plumbing.

EXCLUSIVE REMEDY

Aquatic will, **at its option**, repair or replace (without removal or installation) the affected components of any defective Unit or System; repair or replace (without removal or installation) the entire defective Unit or System; or refund the then-current list price of the Whirlpool, Air Bath, or Tub. In all cases, a reasonable time period must be allowed for warranty repairs to be completed.

WHAT YOU MUST DO

In order to make a claim under these warranties:

1. You must be the original consumer purchaser of the Whirlpool, Air Bath, or Tub.
2. You must promptly notify us within the warranty period of any defect and provide us with any substantiation that we may reasonably request. Write to: **Aquatic 1521 No. Cooper, Ste. 500 Arlington, TX 76011.**
3. The Whirlpools, Air Baths, and Tubs must have been installed and maintained in accordance with good industry practice and the specific Aquatic directions contained in the Owner's Manual and Installation Guide.

EXCLUSIONS

These warranties do not extend to or do not cover defects caused by:

1. Shipping damage by carriers or installation errors.
2. Accident, acts of God, abuse or misuse.
3. Unreasonable use (including any use for non-bathing purposes or failure to provide reasonable and necessary maintenance as specified in Aquatic Owner's Manual and Installation Guide supplied with the Whirlpool, Air Bath or Tub).
4. Any alteration, customization, or modification of the Whirlpool/Air Bath/Tub or its components.

LIMITATIONS

1. **Aquatic whirlpools and tubs sold for industrial, commercial and hotel use** are warranted for two years, but not more than 3 years from date of manufacture, with a 2 year limited warranty that the shell will retain its structural integrity and configuration and be free of water loss due to a defect in the tub. The interior surface/face of the whirlpool/air bath/tub is warranted against fading, blistering, cracking and delamination due to defects in the surface materials for 2 years as well. All support equipment, components, controls and plumbing equipment and limited labor on the support equipment, controls, or plumbing are warranted for 1 year from date of purchase, but not more than 2 years from date of manufacture. Pump seals, "O" rings, light bulbs, fuses and pillows are not included in this two-year period. However, these accessories are warranted to be free from defects in materials and workmanship at the time of delivery to the original purchaser.
2. **In all cases, Aquatic reserves the right to fully satisfy its obligations under the Limited Warranties by refunding the then-current list price of the defective Whirlpool, Air Bath, or Tub (or, if the Whirlpool, Air Bath, or Tub has been discontinued, of the most nearly comparable current product).**
3. **THESE WARRANTIES ARE NON-TRANSFERABLE TO ANY OTHER PURCHASER OR PARTY OTHER THAN THE ORIGINAL CONSUMER. NO OTHER AGENT OR PARTY CAN GIVE ANY OTHER WARRANTY OR PROMISE. THIS IS THE SOLE WARRANTY FOR YOUR Aquatic PRODUCT.**
4. Aquatic will not cover any installation or reinstallation costs related to this warranty, except under the limited labor allowance under the 2 Year Equipment Warranty above.

GENERAL

This warranty gives you specific legal rights; you may also have other rights, which vary from state to state. THE DURATION OF ANY IMPLIED WARRANTIES, INCLUDING THE IMPLIED WARRANTIES OF MERCHANTABILITY AND FITNESS FOR A PARTICULAR PURPOSE, ARE LIMITED TO THE DURATION OF THE EXPRESS WARRANTIES HEREIN. Aquatic EXPRESSLY EXCLUDES INCIDENTAL AND CONSEQUENTIAL DAMAGES, TO INCLUDE LOSS OF TIME, INCONVENIENCE, OR LOSS OF USE OF RESIDENCE, FOR ANY BREACH OF THE EXPRESS OR IMPLIED WARRANTY, INCLUDING THE IMPLIED WARRANTIES OF MERCHANTABILITY OR FITNESS FOR A PARTICULAR PURPOSE.

SOME STATES DO NOT ALLOW ANY LIMITATION ON HOW LONG AN IMPLIED WARRANTY LASTS, OR THE EXCLUSION OR LIMITATION OF INCIDENTAL OR CONSEQUENTIAL DAMAGES; SO THE ABOVE EXCLUSION MAY NOT APPLY TO YOU.



AQUATIC

Where Inspiration Takes Shape

AQUATIC

Fax-On-Demand System: Toll Free (877) 618-7024

8101 E. Kaiser Blvd. • Anaheim, CA 92808

(800) 945-2726 • Fax (866) 544-5353 • www.aquaticbath.com

8MANLUX | F.O.D. 9002

LAOM6 12/12