



Certified to comply with ANSI A112.18.1M

M965115_Rev.1.2

QUINCE™

4433.001

SINGLE CONTROL KITCHEN FAUCET WITH CAST SPOUT

Thank you for selecting American-Standard... the benchmark of fine quality for over 100 years.

To ensure that your installation proceeds smoothly—please read these instructions carefully before you begin.

Recommended tools

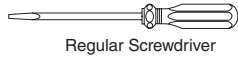

Regular Screwdriver



Phillips Screwdriver



Adjustable Wrench



Plumbers' Putty or Caulking

1 INSTALL FAUCET WITH OR WITHOUT DECK ESCUTCHEON **CAUTION** Turn off hot and cold water supplies before beginning.

- Make certain the SEAL (9) is properly seated in recess of spout base.
- **(A) Installation with ESCUTCHEON (1).** Apply a bead of putty to bottom edge of ESCUTCHEON with PUTTY PLATE (1). Insert supply HOSES (2) and SHANK (3) through hole of ESCUTCHEON with PUTTY PLATE (1) and mounting surface. Follow mounting instructions below to secure faucet to mounting surface.
- **(B) Installation less ESCUTCHEON (1).** Insert all HOSES (2) and SHANK (3) through MOUNTING RING (10) and mounting surface. Do not use putty.
- Assemble RUBBER WASHER (4), BRASS WASHER (5), and threaded LOCKNUT (6) onto SHANK (3) from underside of sink or mounting surface. Hand tighten LOCKNUT (6) and check that rotation of HANDLE (7) from HOT to COLD is centered.
- Use a screwdriver to tighten SCREWS (8) on LOCKNUT (6). Work your way around LOCKNUT (6), tightening the screws slightly each time until all are snug to ensure even pressure.

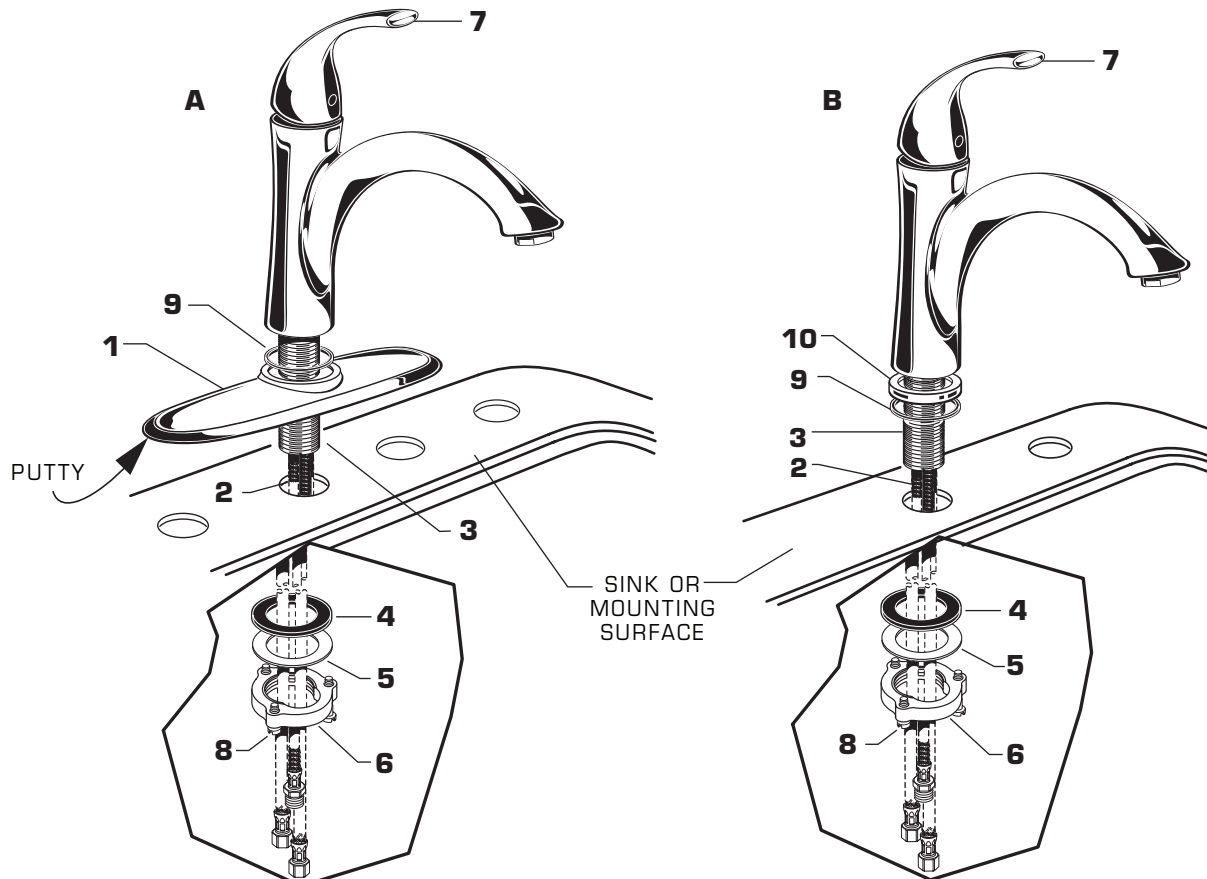

2 MAKE WATER SUPPLY CONNECTIONS

- Turn off hot and cold water supplies before beginning.
- Connect FLEXIBLE SUPPLIES (1, 2) directly to wall supplies. Connection on fitting supplies are 3/8" compression. Connect left supply to Hot (**Marked with a Red Line**) and right supply to Cold wall supply. Use adjustable wrench to tighten connections. Do not over tighten.
- Faucet supplies are 21" long from faucet base.
- **Note: If additional supply length is required, installer must purchase additional parts separately.**
- **Important: If SUPPLY HOSES (1, 2) are too long, loop as illustrated to avoid kinking.**

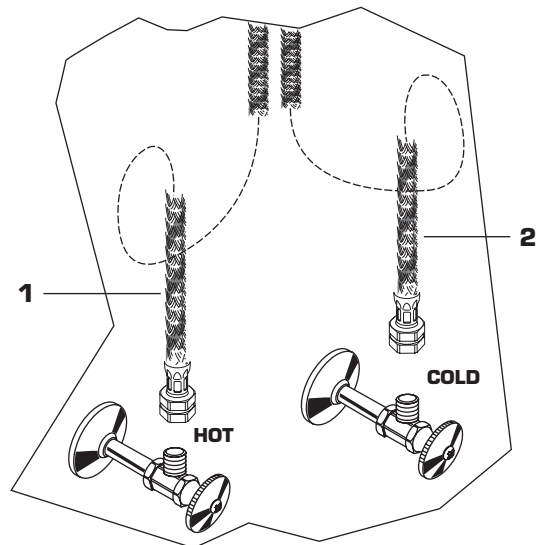

3 INSTALL SPRAY HOLDER

- On model with separate spray, place the SPRAY HOLDER (1) into the appropriate mounting hole. Assemble the SPRAY HOLDER WING NUT (2) onto the shank of SPRAY HOLDER (1) from below and hand tighten. **Do not use putty.**
- For installation less spray, cap off SPRAY HOSE CONNECTION (3) with PIPE CAP (4).

CONNECT HOSE SPRAY

- Feed SPRAY HOSE (5) through SPRAY HOLDER (1) and attach COUPLING NUT (6) of HOSE (5) to SPRAY HOSE CONNECTION (3) on valve body. Tighten COUPLING NUT (6) firmly.

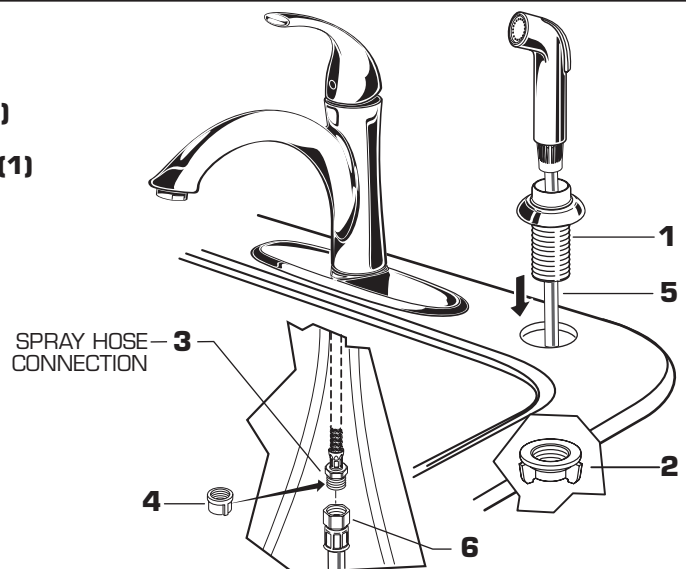

4 TEST INSTALLED FAUCET

- Move HANDLE down into "off" position and remove AERATOR (1).
- Turn on water supplies and check connections for leaks. ➡
- Operate HANDLE (2) up and down, left and right to flush water lines thoroughly.
- For faucet with spray, direct SPRAY HEAD (3) into sink and activate SPRAY (3). Check hose connections for leaks. ➡
- Move HANDLE (2) down to "off" position and replace AERATOR (1).

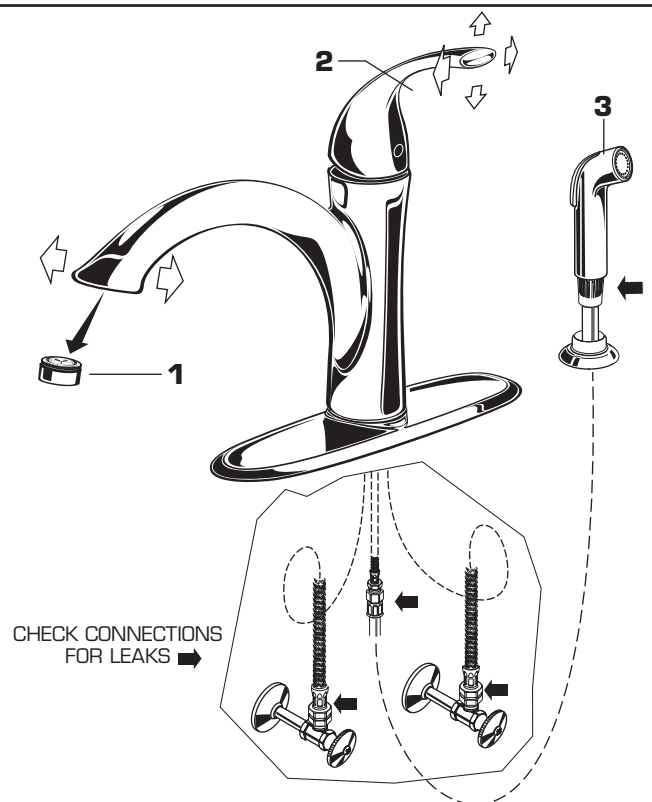

5 SERVICE

Reduced flow. If the flow gradually reduces over a number of months, the AERATOR (12) may have collected debris. To clean, remove AERATOR (12) and rinse with water and remove any debris. Turn on faucet to wash any debris out of the faucet. Thread AERATOR (12) back into spout. Operate faucet.

■ **Spout leakage.** If fitting leaks above or below SPOUT HUB remove SPOUT as follows and check SPOUT O-RINGS. First turn off water supply.

■ Remove HANDLE BUTTON (2) and loosen SET SCREW (1) with 2.5mm HEX WRENCH (11) supplied. Pull HANDLE (3) off valve stem.

■ Pull off CAP (4). Loosen CARTRIDGE SCREWS (5) and remove CARTRIDGE (6).

■ Remove SPOUT (7) by pulling up gently while moving SPOUT (7) side to side.

■ Check both SPOUT O-RINGS (8) for damage. Replace if necessary.

■ On models with SPRAYS, DIVERTER (9) can be cleaned by pulling DIVERTER (9) out of the MANIFOLD (10). Rinse clean the DIVERTER (9) and MANIFOLD (10). Push DIVERTER (9) back into MANIFOLD (10).

■ Reverse procedure to reinstall SPOUT, CARTRIDGE and HANDLE.

■ **Clogged CARTRIDGE outlets or inlets may cause reduced flow.** To clean, first turn off water supply then:

■ Remove PLUG BUTTON (2), loosen HANDLE SCREW (1) and remove HANDLE (3).

■ Remove ESCUTCHEON CAP (4). Unscrew the three CARTRIDGE SCREWS (5). Clean MANIFOLD (10), CARTRIDGE (6) ports and SEALS (13).

■ Clean inlets of CARTRIDGE (6) and MANIFOLD (10).

■ Reassemble CARTRIDGE (6), alternately tightening SCREWS (5). Replace CAP (4) and HANDLE (3). Check flow.

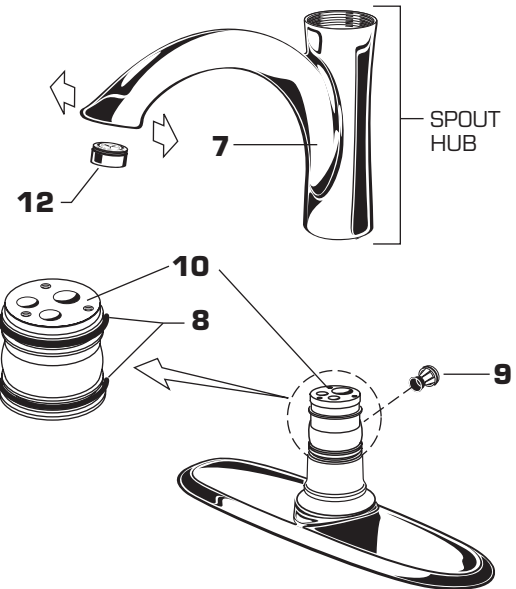
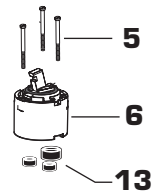
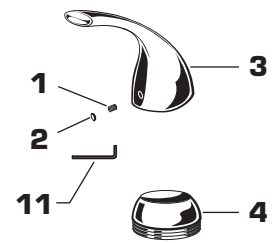

6 CARE INSTRUCTIONS:

DO: SIMPLY RINSE THE PRODUCT CLEAN WITH CLEAR WATER. DRY WITH A SOFT COTTON FLANNEL CLOTH.

DO NOT: DO NOT CLEAN THE PRODUCT WITH SOAPS, ACID, POLISH, ABRASIVES, HARSH CLEANERS, OR A CLOTH WITH A COARSE SURFACE.